



ATD-80355

Corded / Cordless 15-Watt LED Underhood Light

Owner's Manual



Features:

- Performance of a corded light with the convenience of a rechargeable light
- LED battery capacity indicator
- Larger hooks for easy attachment and increased stability
- Bar extends 47"-75" wide and ratchets for light direction
- UL/cUL listed charger and cord
- 16' 18/2 SJTOW cord + DC plug system; cord remains flexible in cold weather and is oil and grease resistant

Specifications:

- 15W High - 1200 lumen
- 7W Low - 600 Lumen
- 7.4V 4000 mAh Lithium-Ion battery
- Cordless run time: Up to 4 hours
- Charge time: 4 hours

WARNING

WARNING: This product contains chemicals, including lead, known to the State of California to cause cancer, birth defects or other reproductive harm. *Wash hands after handling.*

General Safety Warnings:

 **WARNING:** The instructions and warnings contained in this manual should be read and understood before using or operating this tool. Do not allow anyone to use or operate this tool until they have read this manual and have developed a thorough understanding of how this tool works. Failure to observe any of the following instructions could result in severe personal injury to tool user and bystanders, or cause damage to the tool and property. Keep this manual for future reference.





Note: The warnings and cautions discussed in this instruction manual cannot cover all possible conditions and situations that may occur. It must be understood by the operator that common sense and caution are factors which cannot be built into this product, but must be supplied by the operator.

 **WARNING:** Use safety equipment. Users and bystanders should use safety goggles or safety glasses with side shields which comply with current national standards, or when needed, a face shield. Use an ANSI approved dust mask or respirator when working around metal, wood, and chemical dusts and mists. This applies to all persons in the work area. Also use non-skid safety shoes, hardhat, gloves, dust collection systems, and hearing protection when appropriate.

 **WARNING:** Keep bystanders and children out of the work area while operating this tool.

 **WARNING:** Always keep your work area clean, uncluttered, and well lit. Cluttered or dark areas invite accidents and injuries. DO NOT work on floor surfaces that are slippery.

 **WARNING:** Do not operate this tool if you are tired or under the influence of alcohol, drugs, or medications that could affect your ability to use the tool properly.

 **WARNING:** Dress properly. Do not wear loose clothing or jewelry as they can be caught in moving parts. Wear restrictive hair covering to contain long hair.

 **WARNING:** Do not reach over or across running machines. Keep proper footing and balance at all times. Non-skid footwear is recommended when working.

Electrical Safety Warnings:

 **WARNING:** Read all safety warnings and instructions. Failure to follow all warnings and instructions may result in electric shock, fire and/or serious injury or death.

 **WARNING:** Before connecting a tool to a power supply, always check to ensure the power supply corresponds to the voltage on the nameplate of the tool. A power supply with a voltage greater than that specified for the tool can result in serious injury to the user, as well as damage to the tool. Using a power supply with a voltage less than the nameplate rating is harmful to the motor. If in doubt, do not plug in the tool.

 **WARNING:** Grounded tools must be plugged into an outlet properly installed and grounded in accordance with all codes and ordinances. This tool is equipped with a 3-prong plug and a 3-wire grounding system. Never remove the grounding prong or modify the plug in any way. Do not use any adapter plugs. Check with a qualified electrician if you are in doubt as to whether the outlet is properly grounded.





NOTE: Double insulated tools are equipped with a polarized plug (one blade is wider than the other). This plug will fit in a polarized outlet only one way. If the plug does not fit fully in the outlet, reverse the plug. If it still doesn't fit, contact a qualified electrician to install a polarized outlet. Do not change the plug in any way.

 **WARNING:** To reduce the risk of electric shock, DO NOT use in damp conditions, on wet surfaces, or expose to rain. Do not plug in this tool or operate it with wet hands or while standing in water.

 **WARNING:** Never use the cord for carrying, pulling or unplugging the power tool. Grasp plug and pull to disconnect from outlet. Keep cord away from heat, oil, sharp edges or moving parts. Replace damaged cords immediately.

 **WARNING:** Do not carry the power tool with your finger on the switch. Ensure the switch is in the off position before plugging the tool into the power outlet. In the event of a power failure while a tool is being used, turn the switch off to prevent surprise starting when the power is restored.

 **WARNING:** Always remove the power cord from the electric outlet when making adjustments, changing parts, cleaning or working on the tool.

 **WARNING:** Care should be taken to arrange the cord so it will not be stepped on, tripped over, or otherwise subjected to damage or stress.

 **WARNING:** Never attempt to plug in or operate equipment with defective or damaged wires, power cord or power cord plug. Have any defective or damaged parts replaced immediately by qualified personnel.

 **WARNING:** Avoid body contact with electrically grounded surfaces. There is an increased risk of electric shock if your body is grounded.

 **WARNING:** If the work area is not equipped with a permanently installed Ground Fault Circuit Interrupter outlet (GFCI), use a plug-in GFCI between the power tool or extension cord and the power receptacle.

 **WARNING:** If an extension cord is necessary, use only 'Listed' extension cords. If used outdoors, they must be marked "For Outdoor Use". Those cords having a 3-prong grounding type plugs and mating receptacles are to be used with grounded tools.

 **WARNING:** Use of improper size or gauge of extension cord may cause unsafe or inefficient operation of your tool, or cause damage to your tool. Be sure your extension cord is rated to allow sufficient current flow to the motor. If in doubt, always use a larger gauge cord. Be sure to check the voltage requirements of the tool to your incoming power source.

 **NOTE:** The table below shows the correct size to use according to cord length and the amperage draw of the tool (specified on the nameplate). When in doubt, use the next heavier gauge. The smaller the gauge number, the heavier the cord. (AWG = American Wire Gauge).

Minimum Gauge for Extension Cords (AWG)
(when using 120 volts only)

Ampere Rating		Total Length of Cord in Feet (meters)			
More Than	Not More Than	25' (7.6m)	50' (15m)	100' (30.4m)	150' (45.7m)
0	6	18	16	16	14
6	10	18	16	14	12
10	12	16	16	14	12
12	16	14	12	Not Recommended	

ATD-80355 Specific Safety Instructions:

 **WARNING:** Read all instructions before using

 **WARNING:** For indoor use only – do not use in or around, tubs, showers, sinks, pools, hot tubs, or in a wet environment

 **WARNING:** Use only the recommended voltage and frequency requirements

 **WARNING:** Do not move or turn off light by pulling the power cord

 **WARNING:** Do not use if the cords or clear tube are damaged

 **WARNING:** Keep out of reach of children

 **WARNING:** Do not operate light with wet hands.

 **WARNING:** Keep lamp away from hot objects.

Operating Instructions:

DC operating instructions

- To use, plug the unit into any 110-120V AC power source, such as a wall receptacle. Let the unit fully charge until the green indicator on the charger turns on before use.
- Charge this light every month if not in constant use, and after each use, if it is used often to ensure longevity.
- Press “I” : 7W
Press “II” : 15W
OFF: “O”

AC operating instructions:

- To use, plug the unit into any 110-120V AC power source, such as a wall receptacle.
- Press “I” : 7W
Press “II” : 15W
OFF: “O”



- The hooks can be adjusted by simply pulling out on them and affixing to whatever surface you like, such as a car hood. (Up to 75” wide)



- Once your light is in place, it can be rotated to the desired position by simply twisting the light. You will hear ratcheting “clicks” as you rotate it.

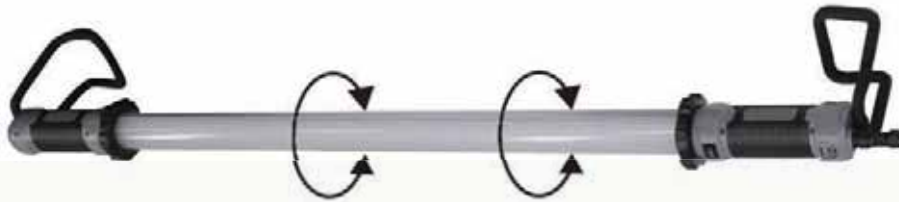

SABER®

ATD-80355

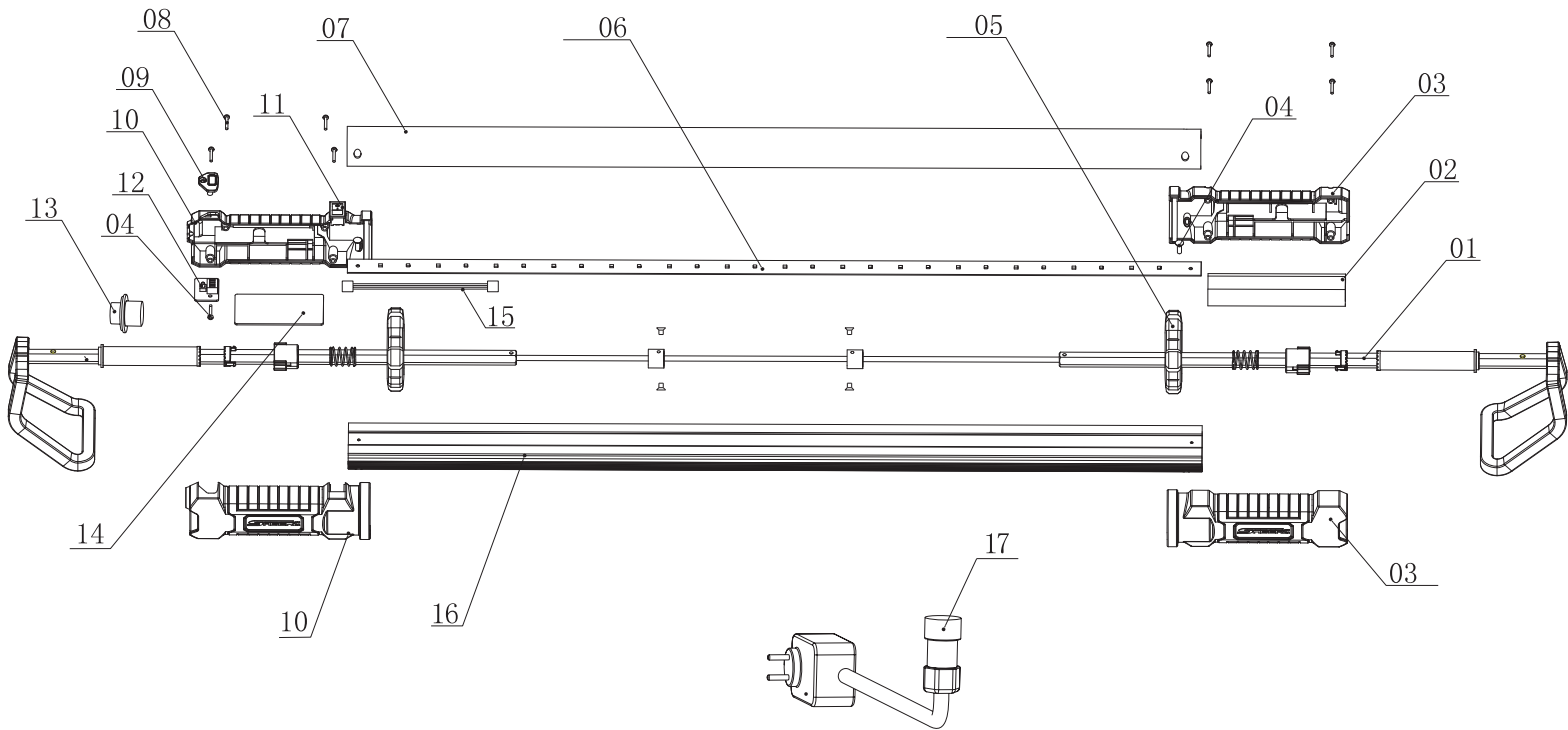

ITEM#	ORDERING PART#	PART DESCRIPTION
1	PRT80355-01	PULL ROD ASSY
2	PRT80352-03	LI-ION BATTERY
3	PRT80351-03	LEFT HANDLE SET
4	PRT80355-04	SCREW ST2. 9*6
5	PRT80351-05	PROTECTING COVER
6	PRT80355-06	LED PCB
7	PRT80351-07	CLEAR TUBE LOWER
8	PRT80351-08	SCREW ST2. 9*16
9	PRT80351-09	BATTERY INDICATOR COVER

ITEM#	ORDERING PART#	PART DESCRIPTION
10	PRT80355-10	RIGHT HANDLE SET
11	PRT80355-11	SWITCH
12	PRT80352-13	BATTERY CAPACITY INDICATOR
13	PRT80355-13	CONNECTOR
14	PRT80355-14	R&C CONSTANT FLOW PLATE
15	PRT80355-15	WIRES
16	PRT80351-19	ALUMINUM TUBE UPPER
17	PRT80357-13	CHARGER / CORD

Made in China to ATD Tools, Inc. Specifications
 Visit us at www.atdtools.com