



ATD-7430A / ATD-7431A 1/2 Ton Telescopic Transmission Jack Owner's Manual



ATD-7430A

ATD-7430A Features:

- Extra wide base lowers center of gravity and promotes stability
- Rugged polyurethane wheels for smooth and easy movement
- Foot release pedal provides controlled lowering of load
- Saddle adjusts to fit most pan configurations
- Chrome-plated, two-stage rams maximize the high reach
- Nylon strap secures transmission to jack
- Meets or exceeds ASME/PASE 2014 standards

ATD-7430A Specifications:

- Capacity (Ton): 1/2
- Minimum Height: 35.24"
- Maximum Height: 75.65"
- Saddle Base: 7.1" x 7.1"
- Saddle Area Min.: 11.4" x 11.4"
- Expanded Saddle Area Max.: 18.7" x 18.7"
- Shipping Weight: 187 lbs.



ATD-7431A

ATD-7431A Features:

- Extra wide base lowers center of gravity and promotes stability
- Rugged polyurethane wheels for smooth and easy movement
- A unique, foot release pedal provides controlled lowering of load
- Adjustable saddle for quick adjustment for most pan configurations
- Chrome-plated, two-stage rams maximize it's high reach
- A compact, yet powerful air motor is equipped to raise the load to the desired height efficiently, effortlessly and safely
- Nylon strap secures transmission to jack
- Meets or exceeds ASME/PASE 2014 standards

ATD-7431A Specifications:

- Capacity (Ton): 1/2
- Minimum Height: 35"
- Maximum Height: 73.5"
- Saddle Area Min.: 7.1" x 7.1"
- Expanded Saddle Area Max.: 18.7" x 18.7"
- Air Pressure: 101-145 psi
- Shipping Weight: 165 lbs.

SAFETY AND GENERAL INFORMATION

Save these instructions. For your safety, read, understand, and follow the information provided with and on this device before using. The owner and/or operator should have an understanding of the device, its operating characteristics and safety operating instructions before operating the equipment. The owner and/or operator should be aware that use and repair of this product may require special skills and knowledge. Instructions and safety information should be read to and discussed with the operator in the operator's native language, making sure that the operator comprehends their contents, before use of this equipment is authorized. If any doubt exists as to the safe and proper use of this device, remove from service immediately.

Inspect before each use. Do not use if abnormal conditions such as cracked welds, damaged, loose or missing parts are noted. Any equipment that appears damaged in any way, is found to be worn, or operates abnormally should be removed from service until repaired. If the equipment has been or is suspected to have been subjected to an abnormal load or shock, immediately discontinue use until inspected by a factory authorized repair facility (contact distributor or manufacturer for list of authorized repair facilities). It is recommended that an annual inspection be made by an authorized repair facility. Labels and operator's manuals are available from the manufacturer.

 WARNING	
<ul style="list-style-type: none"> • <i>Study, understand, and follow all instructions before operating this device.</i> • <i>Do not exceed rated capacity.</i> • <i>Use only on hard, level surfaces.</i> • <i>Adequately support the vehicle before starting repairs.</i> • <i>The use of this product is limited to removal, installation, and transportation in the lowered position, of transmissions, transfer cases and transaxles.</i> • <i>No alterations should be made to this product.</i> • <i>Only attachments and/or adapters supplied by the manufacturer shall be used.</i> • <i>Failure to heed these markings may result in personal injury and/or property damage.</i> 	

PRODUCT DESCRIPTION

The Hydraulic Transmission Jack is designed to be used as an aid in the removal and installation of automotive and light truck transmissions, transfer cases and transaxles. This telescopic style transmission jack is for use under an overhead lift or in a garage pit. For air option model ATD-7431A, ensure that your air source can dedicate 7.8 CFM @ 101-145 psi to each jack operated.

SPECIFICATIONS

Model	Capacity	Min. Height	Max. Height	Saddle Base	Expanded Saddle Area	Saddle Range of Motion	Weight
ATD-7430A	1,000 lbs.	35.24"	75.65"	7.1" x 7.1"	18.7" x 18.7"	Front: 16.4° Rear: 11° Left: 36.6° Right: 35.2°	187 lbs.
ATD-7431A	1,000 lbs.	35"	73.5"	7.1" x 7.1"	18.7" x 18.7"	Front: 16.4° Rear: 11° Left: 36.6° Right: 35.2°	185 lbs.

PREPARATION

Assembly - Please refer to the exploded view drawing in this manual in order to identify parts

1. Major components included with this jack:
 - a. Hydraulic power unit assembly
 - b. Saddle assembly
 - c. Two base half pieces with hardware
2. Put the hydraulic power unit in an upright position, assemble the legs (part #2-5) to the cylinder (part #1-1) with the bolts (part #2-3), and washers (part #2-4). Apply the same procedure to the other base half. Do not tighten yet.
3. Assemble swivel casters (part #2-1 and Part #2-2) to leg caster brackets
4. Tighten the 8 bolts that assemble in the legs (part #2-5) to the cylinder (part #1-1) in step 2.
5. The hydraulic power unit is equipped with two reservoir fill screws (part # 1-37 and 1-38). The closed shipping screw is installed in the reservoir at the factory so the jack will not leak during shipment. Remove shipping screw and replace with the provided vent screw in the following "Before Use" steps.

Before Use

1. Before using this product, read the operator's manual completely and familiarize yourself thoroughly with the product, it's components and recognize the hazards associated with its use.
2. Verify that the product and application are compatible.
3. Press the release valve pedal to ensure that saddle is fully lowered. Remove shipping screw and replace with provided vent screw (*shipping screw is located above the oil filler screw*)
4. For air option model ATD-7431A, pour a teaspoon of good quality, air tool lubricant into the air supply inlet of the lift control valve. Connect to air supply and operate for 3 seconds to evenly distribute lubricant.

NOTICE: The Model ATD-7431A is equipped with a 1/4" NPT air coupler. If installing a different air coupler, use thread tape or compound on all air connections. To ensure dependable operation, install an inline air dryer and oiler.

5. Ensure that jack rolls freely. Raise and lower the unloaded jack throughout the lifting range before putting into service to ensure the pump operates smoothly. Replace worn or damaged parts and assemblies with factory authorized replacement parts only.

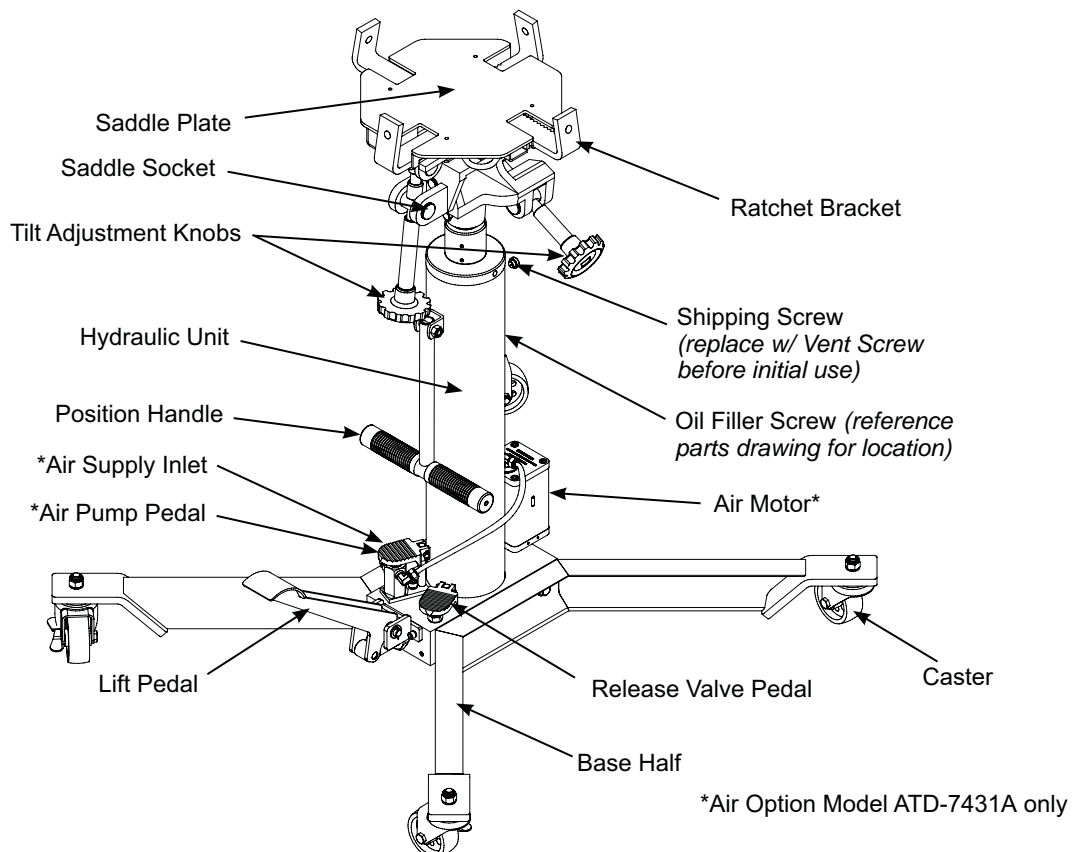

Figure 1- Typical Transmission Jack components (ATD-7431A shown)

PREPARATION *(cont.)*

Venting trapped air procedure

Air can accumulate within a hydraulic system during shipment or after prolonged use. This entrapped air causes the jack to respond slowly or feel "spongy." Use the steps below to bleed the system.

1. Pump the jack to the highest point where the first and the second piston rams are both at maximum height.
2. Get the help of another person to keep the release pedal depressed, and activate the foot pedal about 20 times.
3. Let go of the release pedal; the air in the oil system should be bled successfully.

Follow these steps to bleed the air in the second cylinder:

1. Locate the air bleeder screw at the top nut, which is on the top of the first piston rod.
2. Pump the jack to its maximum height. Use an Allen socket wrench to loosen the air bleeder screw for no more than two 360° turns. Push the saddle assembly downward to push the air in the cylinder out until nothing but oil drains out of the bleeding hole.
3. Tighten the bleeder screw and double check. It may be necessary to repeat the above steps several times.

OPERATION

Follow the instruction for removal and installation of transmission, transfer case or transaxle in accordance with the vehicle manufacturer's service manual. Inspect the jack before each use. Do not use jack if damaged, altered, modified, leaking hydraulic fluid or if it has missing or loose components.

1. Position the transmission jack under the transmission. Depress the foot pedal to raise the saddle to a height close to the center of balance point of the transmission oil pan but do not touch the transmission.
2. Adjust the ratchet arms on the saddle so that the bent up section of the arms will fit in the mounting flange around the perimeter of the transmission oil pan. Slowly pump the jack to make the saddle fully connect the transmission. Secure the transmission to the jack's saddle with the tie down strap provided. If necessary, turn the fore and aft and side to side tilt knobs so the saddle is in the proper alignment with the transmission pan before securing the load to the saddle.

IMPORTANT: Make sure the tie down strap is very tight when securing the transmission to the saddle and before raising or lowering the transmission.

3. Remove the transmission from the engine according to instructions in the vehicle service manual.
4. Once the transmission has been disassembled from the engine, very slowly depress the release pedal to lower the transmission all the way down.

IMPORTANT: Be sure all tools and personnel are clear before lowering load. Slowly depress release valve pedal.

5. When installing a transmission, refer to the above instructions and the vehicle manufacturer's installation manual.

NOTICE: *Do not attempt to operate jack by air and by foot pump simultaneously.*

 **WARNING:** *Ensure load center of gravity is centered on saddle and is stabilized before moving jack. An off-center transmission could cause jack to tip or flip over.*

 **WARNING:** *Do not use this jack as a workstation.*

Lowering saddle:

 **WARNING:** *Clear all tools and personnel before lowering load. Engage release valve pedal slowly. Maintain control of load at all times.*

Apply downward pressure to the release valve pedal slowly and carefully.

MAINTENANCE

NOTICE: Use only good quality hydraulic jack oil. Avoid mixing different types of fluid and NEVER use brake fluid, turbine oil, transmission fluid, motor oil or glycerin. Improper fluid can cause premature failure of the jack and the potential for sudden and immediate loss of load. Premium hydraulic jack oil is recommended.

Changing oil

NOTICE: For best performance and longest life, replace the complete fluid supply at least once per year.

1. With saddle fully lowered, remove oil filler screw.
2. Lay the jack on its side and drain the fluid into a suitable container.

NOTICE: Dispose of hydraulic fluid in accordance with local environmental regulations.

3. Set jack in its level position. Fill reservoir with 2-1/2 quarts of premium hydraulic jack oil. Reinstall oil filler screw.
4. Perform **venting trapped air procedure** (page 4).

Lubrication

1. A periodic coating of light lubricating oil to pivot points, axles and hinges will help to prevent rust and assure that casters and pump assemblies move freely.
2. For air operated models ATD-7431A: When used on a daily basis, air pump model should be internally lubricated before each use. Use only good quality air tool lubricant. If no in-line oiler is used, pour a teaspoon of air tool oil into the air supply inlet. Operate the jack using the air feature to fully distribute the oil.

Cleaning

Dirt is the greatest single cause of failure in hydraulic units. Keep the jack clean and well lubricated to prevent foreign matter from entering the system. If the jack has been exposed to rain, snow, sand, or grit, it must be cleaned before it is used. Periodically check the pump piston and ram for signs of rust or corrosion. Clean as needed and wipe with an oily cloth.

NOTICE: Do not use sandpaper or abrasive material on pump piston or ram surfaces.

Storage

When not in use, store the jack with saddle fully lowered. Store the jack in a well-protected area where it will not be exposed to corrosive vapors, abrasive dust, or any other harmful elements.

Symptom	Possible Causes	Corrective Action
Jack does not lift	1. Release valve is open.	1. Close release valve.
	2. Low/no oil in reservoir.	2. Fill with Oil and bleed system.
	3. Air-locked system.	3. Bleed system.
	4. Load is above capacity of jack.	4. Use correct equipment
	6. Packing worn out or defective.	6. Install seal kit
Jack advances slowly	1. Pump not working correctly.	1. Install seal kit, or replace power Unit.
Jack lifts load, but doesn't hold	1. Cylinder packing is leaking.	1. Install seal kit
	2. Valve not working correctly (suction, delivery, release, or bypass).	2. Inspect valves. Clean and repair seat surfaces.
	3. Air-locked system.	3. Bleed system.
Jack leaks oil	1. Worn or damaged seals.	1. Install seal kit.
Jack will not retract	1. Release valve is closed.	1. Open or clean release valve.

ITEM#	ORDERING PART#	PART DESCRIPTION	QTY
1-1		BASE WELDMENT	1
1-2		STEEL BALL	1
1-3		BALL SEAT VALVE	1
1-4		SPRING	1
1-5		SCREW	1
1-6*		SEAL	1
1-7		SCREW	1
1-8		STEEL BALL	3
1-9		SPRING	1
1-10*		COPPER WASHER	2
1-11		BOLT	2
1-12		SPRING	1
1-13		SUPPORT ROD	1
1-14		BALL SEAT VALVE	1
1-15		NUT	2
1-16		SPRING	1
1-17*		COPPER WASHER	1
1-18		OIL RELEASE VALVE	1
1-19*		O-RING	1
1-20		FIX RING	1
1-21		SNAP RING	1
1-22		OIL RELEASE VALVE ROD	1
1-23		PEDAL	1
1-24		PIN	2
1-25		PEDAL PIN	2
1-26	PRT7430A-11-163	SPRING	1
1-27*	HYDRAULIC CYLINDER	Y-RING	1
1-28*		O-RING	1
1-29		PUMP CORE	1
1-30		SPRING COVER	1
1-31		SNAP RING	1
1-32		BUSHING	1
1-33		AXIS	1
1-34		PEDAL	1
1-35		SNAP RING	2
1-36		AXIS	1
1-37		BOLT	1
1-38		BOLT	1
1-39*		SEAL	1
1-40		NUT	1
1-41		BOLT	1
1-42*		WASHER	1
1-43*		O-RING	1
1-44*		O-RING	1
1-45		PISTON RING	1
1-46		SNAP RING	2
1-47		PISTON RING	1
1-48		MIDDLE CYLINDER	1
1-49		LIMITED COLLAR	1
1-50		GUIDING COLLAR	1
1-51*		OIL PLUG	1
1-52		CAP	1

ITEM#	ORDERING PART#	PART DESCRIPTION	QTY
1-53*		DUST PROOF RING	1
1-54		SNAP RING	1
1-55		PISTON	1
1-56		GUIDING RING	1
1-57*		O-RING	1
1-58	PRT7430A-11-163	CAP	1
1-59*	HYDRAULIC CYLINDER	OIL PLUG	1
1-60*		DUST PROOF RING	1
1-61		BOLT	1
1-62		STEEL BALL	1
1-63		HANDLE ASSEMBLY	1
2-1	PRT7430A-21-26	CASTER W/BOLT AND WASHER	2
2-2	PRT7430A-22-26	LOCKING CASTER W/BOLT AND WASHER	2
2-3		BOLT	8
2-4		WASHER	12
2-5		LEG	2
2-6		BOLT	4
3-1		SADDLE PLATE	1
3-2		PLATE	2
3-3		PLATE	1
3-4		PLATE	1
3-5		LOCATING BLOCK	4
3-5A		LOCATING BLOCK ASSEMBLY	4
3-5B		LEAF SPRING	4
3-5C		RIVET	4
3-6		PIN	4
3-7		LOCATING BLOCK	1
3-8		ADJUSTING BLOCK WELDMENT	1
3-9		ADJUSTING BLOCK	1
3-10		SCREW	1
3-11		SCREW	1
3-12		HANDLE WHEEL	1
3-13		HANDLE WHEEL	1
3-14	PRT7430A-31-332	AXIS	2
3-15	SADDLE ASSEMBLY	AXIS	2
3-16		BUSHING	4
3-17		BUSHING PIN	4
3-18		PIN	2
3-19		BOLT	1
3-20		BOLT	1
3-21		NUT	2
3-22		TIE	1
3-23		BOLT	1
3-24		WASHER	1
3-25		WASHER	1
3-26		BOLT	1
3-27		NUT	1
3-28		HANDLE	1
3-29		WASHER	2
3-30		BOLT	2
3-32		SNAP RING	4

* - PRT7430A-SK - SEAL KIT CONTAINS 1-6, 1-10, 1-17, 1-19, 1-27, 1-28, 1-39, 1-42, 1-43, 1-44, 1-51, 1-53, 1-57, 1-59, 1-60

ATD-7431A Replacement Parts:

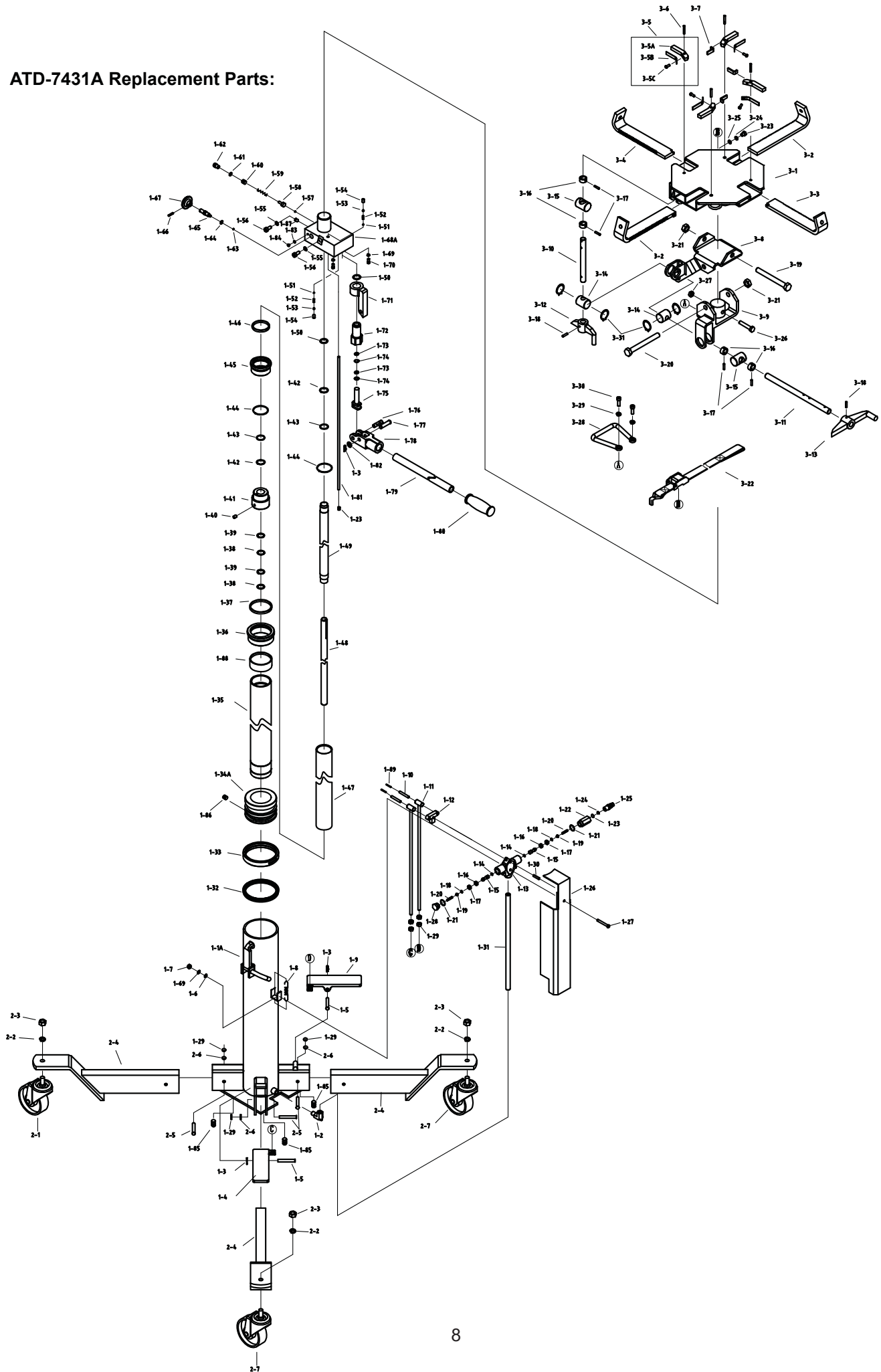

ITEM#	ORDERING PART#	PART DESCRIPTION	QTY
1-1A		AIR WELDMENT	1
1-2		NPT 1/4 COUPLER	1
1-3		PIN	3
1-4		PEDAL A	1
1-5		PIN	2
1-6		WASHER	1
1-7		BOLT	1
1-8		SPRING	1
1-9		PEDAL B	1
1-10		PIN	2
1-11		CONNECTING ROD	2
1-12		CONNECTING ROD JOINT	1
1-13		VALVE	1
1-14		O-RING	2
1-15		VALVE ROD	2
1-16		SEAL	2
1-17		COVER	2
1-18		WASHER	2
1-19		BOLT	2
1-20		SPRING	2
1-21		COPPER WASHER	2
1-22		COUPLER	1
1-23		COUPLER	1
1-24		SNAP RING	1
1-25		COUPLER	1
1-26		COVER	1
1-27		BOLT	1
1-28		CAP	1
1-29		BOLT	8
1-30		PIN	1
1-31		AIR HOUSING	1
1-32	PRT7431A-11A-189	Y-RING	1
1-33	HYDRAULIC	SUPPORTING RING	1
1-34	CYLINDER W/AIR	PISTON	1
1-35	MOTOR	BIG CYLINDER	1
1-36		CAP	1
1-37		GUIDING RING	1
1-38		NYLON GASKET	2
1-39		O-RING	2
1-40		BOLT	1
1-41		MIDDLE CYLINDER CAP	1
1-42		O-RING	2
1-43		NYLON GASKET	2
1-44		O-RING	2
1-45		BIG CYLINDER CAP	1
1-46		GUIDING RING	1
1-47		MIDDLE CYLINDER	1
1-48		PISTON ROD	1
1-49		SMALL CYLINDER	1
1-50		COPPER WASHER	2
1-51		STEEL	2
1-52		SPRING	2
1-53		STEEL BALL	2
1-54		BOLT	2
1-55		COPPER WASHER	2
1-56		BOLT	2
1-57		STEEL BALL	1
1-58		STEEL BALL VALVE SEAT	1
1-59		SPRING	1
1-60		BOLT	1
1-61		SEAL	1
1-62		BOLT	1
1-63		STEEL BALL	1
1-64		O-RING	1
1-65		OIL RELEASE VALVE	1

ITEM#	ORDERING PART#	PART DESCRIPTION	QTY
1-66		PIN	1
1-67		HANDLE WHEEL	1
1-68A		VALVE BLOCK	1
1-69		WASHER	3
1-70		BOLT	2
1-71		CONNECTING ROD SEAT	1
1-72		PUMP BODY	1
1-73		O-RING	2
1-74		SNAP RING	2
1-75		PUMP CORE	1
1-76	PRT7431A-11A-189	PIN	1
1-77	HYDRAULIC	PIN	1
1-78	CYLINDER W/AIR	HANDLE SOCKET	1
1-79	MOTOR	HANDLE	1
1-80		HANLD GRIP	1
1-81		FUEL PIPE	11
1-82		WASHER	1
1-83		WASHER	1
1-84		BOLT	1
1-85		BOLT	4
1-86		BOLT	1
1-87		THROTTLE VALVE	1
1-88		STOP COLLAR	1
1-89		PIN	2
2-1	PRT7430A-21-26	CASTER W/BOLT AND WASHER	2
2-2		WASHER	4
2-3		BOLT	4
2-4		LEG ASSEMBLY	4
2-5		BOLT	4
2-6		WASHER	4
2-7	PRT7430A-22-26	LOCKING CASTER W/BOLT AND WASHER	2
3-1		SADDLE WELDMENT	1
3-2		BRACKET C	2
3-3		BRACKET B	1
3-4		BRACKET A	1
3-5		RETAINER PLATE ASSEMBLY	4
3-5A		RETAINER PLATE	4
3-5B		SPRING	4
3-5C		RIVET	4
3-6		PIN	4
3-7		RETAINER PLATE A	1
3-8		ADJUSTING BRACKET	1
3-9		ADJUSTING BRACKET A	1
3-10		SCREW B	1
3-11		SCREW A	1
3-12		HANDLE B	1
3-13		HANDLE A	1
3-14	PRT7430A-31-332	SHAFT	2
3-15	SADDLE ASSEMBLY	SHAFT	2
3-16		BUSHING	4
3-17		PIN	4
3-18		PIN	2
3-19		BOLT	1
3-20		BOLT	1
3-21		LOCK NUT	2
3-22		TIE	1
3-23		BOLT	1
3-24		WASHER	1
3-25		WASHER	1
3-26		BOLT	1
3-27		NUT	1
3-28		GRIP	1
3-29		WASHER	2
3-30		BOLT	2
3-31		SNAP RING	4

* PRT7431A-SK - SEAL KIT CONTAINS: 1-32, 1-38, 1-39, 1-42, 1-43, 1-44, 1-50, 1-55, 1-61, 1-64, 1-73, 1-74



ATD[®]

WARRANTY

1 YEAR LIMITED WARRANTY

THIS WARRANTY AND CONFIRMED RECEIPT(S) SHOULD BE RETAINED BY THE CUSTOMER AT ALL TIMES

PURCHASED FROM: _____

DATE PURCHASED: _____

INVOICE/RECEIPT NUMBER: _____

Your ATD-7430A or ATD-7431A is warranted for a period of 12 months from the original purchase date.

For a period of one (1) year from your purchase date, ATD Tools, Inc. will repair or replace (at its option) without charge, your ATD product if it was purchased new and the product has failed due to a defect in material or workmanship which you experienced during normal use of the product. This limited warranty is your exclusive remedy.

To access the benefits of this warranty, contact your supplier, or point of sale directly. You may be advised to return the product under warranty, freight prepaid, to your supplier for warranty determination.

If this ATD product is altered, abused, misused, modified, or undergoes service by an unauthorized technician, your warranty will be void. We are not responsible for damage to ornamental designs you place on this ATD product and such ornamentation should not cover any warnings or instructions or they may void the warranty. This warranty does not cover scratches, superficial dents, and other abrasions to the paint finish that occur under normal use. It also does not cover normal wear items such as but not limited to brushes, batteries, drill bits, drill chucks, pads or blades.

Subject to the law in your state:

- (1) Your sole and exclusive remedy is repair or replacement of the defective product as described above.
- (2) ATD is not liable for any incidental damages, including but not limited to, lost profits and unforeseeable consequences.
- (3) The repair and replacement of this product under the express limited warranty described above is your exclusive remedy and is provided in lieu of all other warranties, express or implied. All other warranties, including implied warranties and warranties of merchantability or fitness for a particular purpose are disclaimed and, if disclaimer is prohibited, these warranties are limited to one year from your date of purchase of this product.

Some states' laws do not allow limited durations on certain implied warranties and some states' laws do not allow limitations on incidental or consequential damages. You should consult the law in your state to determine how your rights may vary.

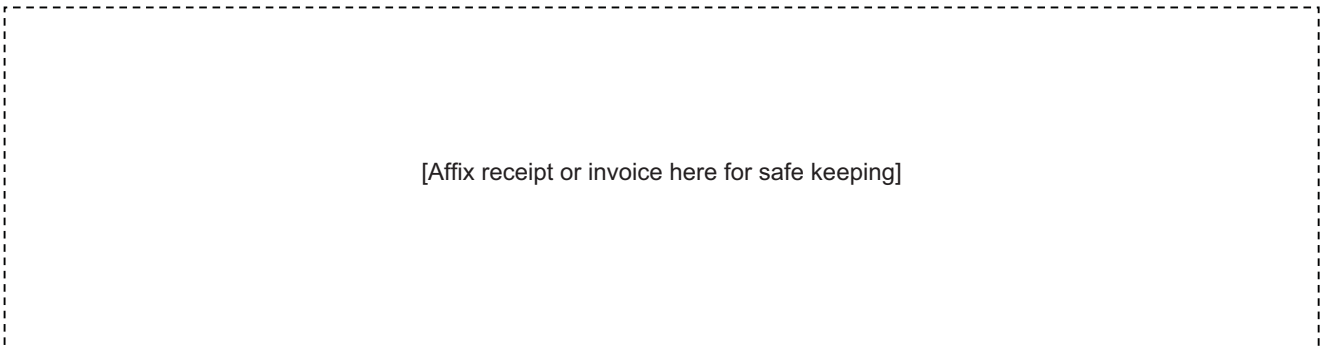

[Affix receipt or invoice here for safe keeping]