



ATD-7382W 6-Ton Bottle Jack Owner's Manual



Features:

- Welded design for greater strength and eliminates leaks
- Chrome plated piston and ram for increased rust resistance and durability
- Extension screw for height adjustment
- Overload by-pass safety system prevents damage to jack
- Meets ASME PALD-2014 and CE standards

Specifications

- Capacity: 6-Ton
- Min. Height: 8.27" (210 mm)
- Max. Height: 16.38" (416 mm)
- Net Weight: 8.60 lbs. (4.2 kg)

These instructions have been written to help the user more effectively use and maintain this jack. Some of the information applying to construction, installation, operation, inspection, and maintenance of hydraulic jacks was selected from ANSI B30.1 and ASME/ANSI PALD-1 safety standards for jacks.

Product Description

This ATD Hydraulic Bottle Jack is designed to lift, but not sustain, rated capacity loads. It's designed to be used vertically. After lifting, loads must be immediately supported by appropriate means. This ATD Hydraulic Bottle Jack is suitable for use in an appropriately rated and designed vertical position bench press structure. It is **NOT** recommended for use in positioning construction trailers, houses or other building structures.

Safety Precautions

WARNING: Failure to heed the following warnings can result in personal injury and/or equipment damage. These warnings cannot cover every situation, so have safety foremost in your mind when using this jack.

- Read, understand, and follow the operating instructions, and the ANSI B30.1 and ASME PALD-1 safety standard for jacks. If the operator cannot read English, operating instructions and safety precautions must be read and discussed in the operator's native language.
- Wear eye protection that meets the requirements of ANSI Z87.1 and OSHA.
- Inspect the jack before each use; do not use the jack if it is damaged, altered, or in poor condition.
- To prevent tipping, set up the jack on a hard, level surface. Set vehicle parking brake and block tires.
- The load must not exceed the rated lifting capacity of the jack. Lift only dead weight.
- Center the load on the jack saddle, because off-center loads can damage seals and cause hydraulic failure.
- Use the jack for lifting purpose only. This jack is designed to LIFT loads, NOT SUPPORT loads. Immediately support a lifted load with jack stands.
- Stay clear of lifted loads.
- Use only approved hydraulic fluid, such as Mobil DTE13M or equivalent.

Operating Instructions

- To raise the jack, use narrow end of jack handle to tighten release valve clockwise (CW). Insert handle into socket, and operate pump.
- To lower the jack, **SLOWLY** open the release valve knob by turning it counterclockwise (CCW).

Preventive Maintenance

Important: Dirt is the greatest single cause of failure in hydraulic units. Keep the jack clean and well lubricated to prevent foreign matter from entering the system. If the jack has been exposed to rain, snow, or grit, it must be cleaned before it is used.

1. When the jack is not in use, keep the piston fully retracted. Store the jack on its base and in a well protected area where it will not be exposed to corrosive vapors, abrasive dust, or any other harmful elements.
2. Maintain the oil level at the bottom of the filler plug hole. If it is necessary to add oil, remove the filler plug, and fill the reservoir with Mobil DTE13M or equivalent.
3. Visually inspect the jack before each use. Take corrective action if any of the following problems are found:
 - a. Cracked or damaged housing
 - b. Excessive wear, bending, or other damage
 - c. Leaking hydraulic fluid
 - d. Scored or damaged piston rod
 - e. Incorrectly functioning swivel heads or adjusting screw
 - f. Loose hardware
 - g. Modified or altered equipment

Maintenance

Important: Use only a good grade hydraulic jack oil. Avoid mixing different types of fluid and **NEVER** use brake fluid, turbine oil, transmission fluid, motor oil or glycerin. Improper fluid can cause failure of the jack and the potential for sudden and immediate loss of load. We recommend Mobil DTE13M or equivalent.

Adding oil

1. With saddle fully lowered and pump piston fully depressed, set jack in its upright, level position. Remove oil filler plug.
2. Fill until oil is level with the filler screw hole, reinstall oil filler plug.

Changing oil

For best performance and longest life, replace the complete fluid supply at least once per year.

1. With saddle fully lowered, remove the oil filler screw.
2. Lay the jack on its side and drain the fluid into a suitable container.

Note: Dispose of hydraulic fluid in accordance with local regulations.

3. Set jack in its upright, level position. Fill until oil is level with the filler screw hole, reinstall oil filler screw.

Lubrication

A periodic coating of light lubricating oil to pivot points and hinges will help to prevent rust and assure that pump assemblies move freely.

Cleaning

Periodically check the pump piston and ram for signs of rust or corrosion. Clean as needed and wipe with an oily cloth. **Note:** Never use sandpaper or abrasive material on these surfaces.

Troubleshooting

Symptom	Possible Causes	Corrective Action
Jack will not lift load	<ul style="list-style-type: none">• Release valve not tightly closed	<ul style="list-style-type: none">• Ensure release valve tightly closed
Jack bleeds off after lift	<ul style="list-style-type: none">• Hydraulic unit malfunction• Release valve not tightly closed	<ul style="list-style-type: none">• Ensure release valve tightly closed• Contact your supplier for service or warranty information.
Jack will not lower after unloading	<ul style="list-style-type: none">• Reservoir overfilled	<ul style="list-style-type: none">• Drain fluid to proper level
Poor lift performance	<ul style="list-style-type: none">• Fluid level low• Air trapped in system	<ul style="list-style-type: none">• Ensure proper fluid level• With ram fully retracted, remove oil filler screw to let pressurized air escape, then reinstall oil filler screw
Will not lift to full extension	<ul style="list-style-type: none">• Fluid level low	<ul style="list-style-type: none">• Ensure proper fluid level

ATD®

ATD-7382W

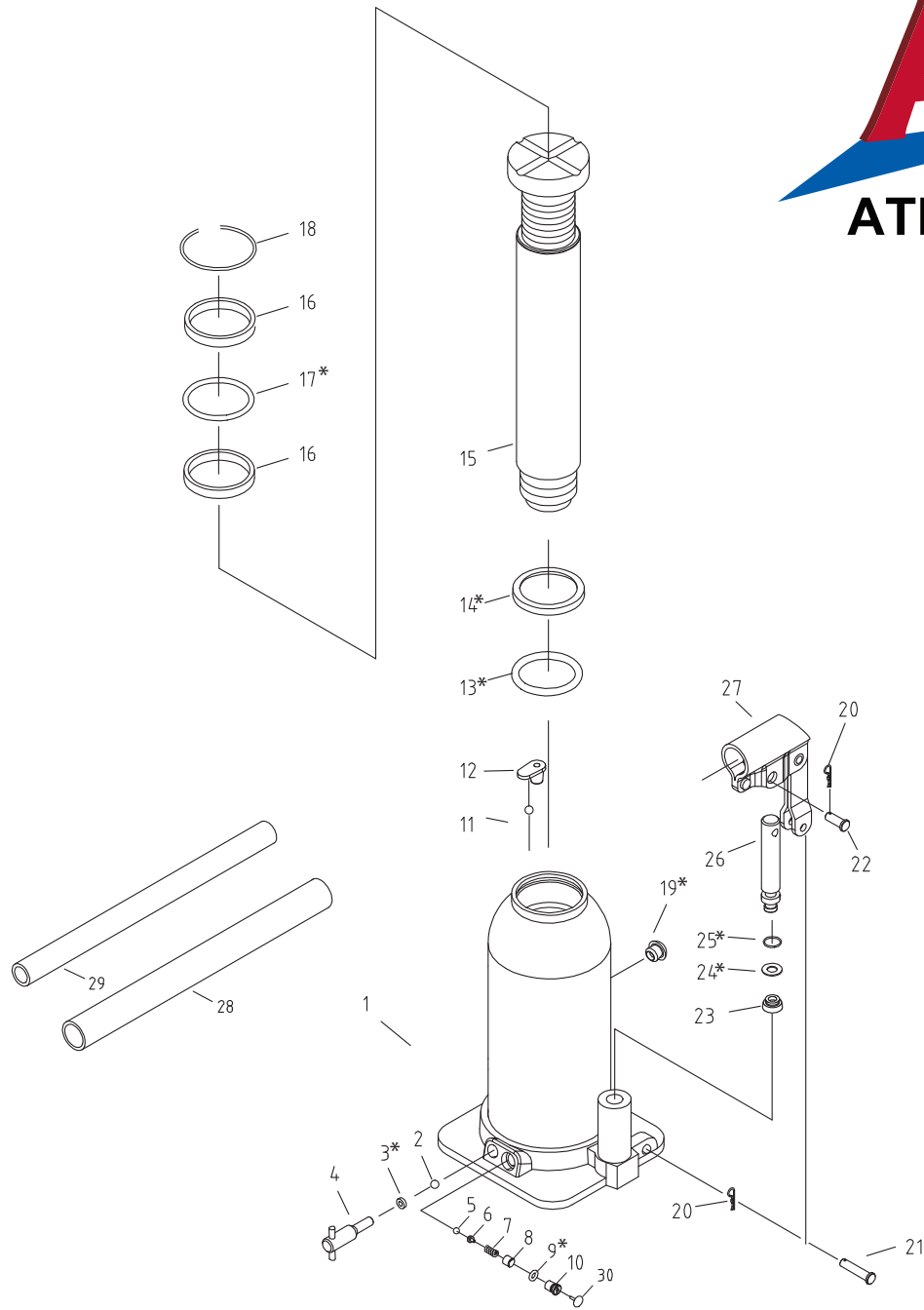

ITEM#	ORDERING PART#	DESCRIPTION
1	n/a	BASE
2	n/a	STEEL BALL
3	PRT7382W-01	*O-RING
4	n/a	RELEASE VALVE ASSEMBLY
5	n/a	STEEL BALL
6	n/a	BALL VALVE SEAT
7	n/a	SAFETY VALVE SPRING
8	n/a	SCREW
9	PRT7382W-01	*SEAL RING
10	n/a	SCREW
11	n/a	STEEL BALL
12	n/a	STEEL PLATE
13	PRT7382W-01	*O-RING
14	PRT7382W-01	*WASHER
15	n/a	PISTON ROD

ITEM#	ORDERING PART#	DESCRIPTION
16	n/a	SECURING RING
17	PRT7382W-01	*O-RING
18	n/a	SNAP RING
19	PRT7380W-03	*OIL PLUG
20	n/a	PIN
21	n/a	CLEVIS PIN
22	n/a	CLEVIS PIN B
23	n/a	Y-RING
24	PRT7382W-01	*NYLON GASKET
25	PRT7382W-01	*O-RING
26	n/a	PUMP PLUNGER
27	PRT7382W-01	HANDLE SOCKET
28	PRT7380W-02	HANDLE ASSEMBLY
29		

Not all components of the jack are replacement items, but are illustrated as a convenient reference of parts location.

Call your distributor for current pricing. When ordering parts, give part number and parts description.

Seal kit contains all items marked with an asterisk (*)



WARRANTY

1 YEAR LIMITED WARRANTY

THIS WARRANTY AND CONFIRMED RECEIPT(S) SHOULD BE RETAINED BY THE CUSTOMER AT ALL TIMES

PURCHASED FROM: _____

DATE PURCHASED: _____

INVOICE/RECEIPT NUMBER: _____

Your ATD-7382W is warranted for a period of 12 months from the original purchase date.

For a period of one (1) year from your purchase date, ATD Tools Inc. will repair or replace (at its option) without charge, your ATD product if it was purchased new and the product has failed due to a defect in material or workmanship which you experienced during normal use of the product. This limited warranty is your exclusive remedy.

To access the benefits of this warranty, contact your supplier, or point of sale directly. You may be advised to return the product under warranty, freight prepaid, to your supplier for warranty determination.

If this ATD product is altered, abused, misused, modified, or undergoes service by an unauthorized technician, your warranty will be void. We are not responsible for damage to ornamental designs you place on this ATD product and such ornamentation should not cover any warnings or instructions or they may void the warranty. This warranty does not cover scratches, superficial dents, and other abrasions to the paint finish that occur under normal use. It also does not cover normal wear items such as but not limited to brushes, batteries, drill bits, drill chucks, pads or blades.

Subject to the law in your state:

- (1) Your sole and exclusive remedy is repair or replacement of the defective product as described above.
- (2) ATD is not liable for any incidental damages, including but not limited to, lost profits and unforeseeable consequences.
- (3) The repair and replacement of this product under the express limited warranty described above is your exclusive remedy and is provided in lieu of all other warranties, express or implied. All other warranties, including implied warranties and warranties of merchantability or fitness for a particular purpose are disclaimed and, if disclaimer is prohibited, these warranties are limited to one year from your date of purchase of this product.

Some states' laws do not allow limited durations on certain implied warranties and some states' laws do not allow limitations on incidental or consequential damages. You should consult the law in your state to determine how your rights may vary.

[Affix receipt or invoice here for safe keeping]