



# ATD-5954 1500W Power Inverter Owner's Manual



## Specifications:

- For use with 12V systems
- Input DC Voltage Range: DC 11V-14V
- Output Voltage: AC100~120V
- Overload and short-circuit protection
- Over voltage and low voltage protection
- Built-in cooling fan
- (2) USB outputs DC 5V (max 3.1A)
- (3) 110V AC 3-prong outlets with waterproof cover
- Modified sine wave
- Maximum Continuous Power: 1500-Watts
- Peak Load Power Rate: Up to 3000-Watts
- Digital LED display

## Includes:

- 6 AWG 30" battery terminal cables (black and red)
- Ground wire (yellow, green)
- (6) Replacement 30A fuses
- (4) Mounting screws

## Welcome

This ATD product has been carefully engineered and manufactured to give you dependable operation. Please read this manual thoroughly before operating your new ATD product, as it contains the information you need to become familiar with its features and obtain the performance that will bring you continued enjoyment for many years. Please keep this manual on file for future reference.

## About ATD Inverters

ATD, an innovator in portable inverter design, has developed a new line of super-efficient power inverters with the highest surge capability in the industry. These extremely advanced, microprocessor controlled units run cooler and more reliable than any in their class. Their superior surge capability, depending on their capacity, allows them to start even the most difficult loads, including televisions, microwaves, refrigeration units, even small air conditioners. They also have the highest efficiency available (up to 90%) which translates into longer running time and extended battery life.

Inverters convert low voltage, direct current (DC) to 110-Volt alternating current (AC). Depending on the model and its rated capacity, the inverters draw power either from standard 12-Volt automobile and marine batteries or from portable high power 12-Volt sources.

Our ATD-5954 inverter has three 110V AC outlets and 2 USB outlets rated at 3.1A for powering laptops, video game systems, DVD players, cell phones, tablets and many other USB devices.

## General Safety Warnings

 **WARNING:** The instructions and warnings contained in this manual should be read and understood before using or operating this unit. Do not allow anyone to use or operate this unit until they have read this manual and have developed a thorough understanding of how this unit works. Failure to observe any of the following instructions could result in severe personal injury to unit user and bystanders, or cause damage to the unit and property. Keep this manual for future reference.

 **Note:** The warnings and cautions discussed in this instruction manual cannot cover all possible conditions and situations that may occur. It must be understood by the operator that common sense and caution are factors which cannot be built into this product, but must be supplied by the operator.

 **WARNING:** Do not operate, setup or plug in this tool if you are tired or under the influence of alcohol, drugs, or medications that could affect your ability to use the tool properly.

 **WARNING:** Do not reach over or across running engines. Keep proper footing and balance at all times.

## Lead Acid Battery Safety Warnings



### **WARNING: WORKING AROUND LEAD-ACID BATTERIES MAY BE DANGEROUS.**

- Lead-acid batteries release explosive gases during normal operation, charging and jump starting.
- All lead-acid batteries (car, truck and boat) produce hydrogen gas which may violently explode in the presence of fire or sparks. **Do not smoke, use matches or a cigarette lighter while near batteries.**
- Only work with lead-acid batteries in a well-ventilated area. Do not handle the battery while wearing vinyl clothing because static electricity sparks are generated when vinyl clothing is rubbed.
- To reduce risk of battery explosion, follow these instructions and those published by the battery manufacturer and manufacturer of any equipment you intend to use in the vicinity of the battery. Review cautionary markings on these products and on engine.

### **EYE PROTECTION:**

- User and bystanders should always wear eye protection, appropriate protective clothing and other safety equipment when working near lead-acid batteries. Do not touch eyes while working on or around lead-acid batteries.
- **IF SPLASHED WITH BATTERY ACID, IMMEDIATELY FLUSH AFFECTED AREA SUCH AS FACE AND PARTICULARLY THE EYES WITH CLEAN WATER. SEEK MEDICAL ATTENTION AND CONTINUE FLUSHING FACE AND EYES UNTIL MEDICAL HELP ARRIVES.**

### **WORKING IN ENGINE COMPARTMENT:**

- Use extreme caution while working within the engine compartment, because moving parts may cause severe injury. Read and follow all safety instructions published in the vehicle's Owner's Manual.

### **GENERAL PRECAUTIONS / PERSONAL PRECAUTIONS:**

- Never work alone with lead-acid batteries. Make sure that someone is around to give assistance if you need help.
- Wear complete eye protection and clothing protection. Avoid touching eyes while working near battery.
- In case of battery acid contact with eyes, skin or clothing, always have soap and water near your work area.
- Remove jewelry such as rings, bracelets, necklaces and watches when working around a battery. A lead-acid battery can produce a short circuit current, which can melt metals and result in a severe burn.
- Do not drop tools or other metal objects on or near the battery as a spark may result, igniting explosive gases.
- Never jump start or attempt to recharge a frozen battery.

## Electrical Safety Warnings

 **WARNING:** Read all safety warnings and instructions. Failure to follow all warnings and instructions may result in electric shock, fire and/or serious injury or death.

 **WARNING:** Before connecting a tool to a power supply, always check to ensure the power supply corresponds to the voltage on the nameplate of the tool. A power supply with a voltage greater than that specified for the tool can result in serious injury to the user, as well as damage to the tool. Using a power supply with a voltage less than the nameplate rating is harmful to the motor. If in doubt, do not plug in the tool.

 **WARNING:** Grounded tools must be plugged into an outlet properly installed and grounded in accordance with all codes and ordinances. This tool is equipped with a 3-prong plug and a 3-wire grounding system. Never remove the grounding prong or modify the plug in any way. Do not use any adapter plugs. Check with a qualified electrician if you are in doubt as to whether the outlet is properly grounded.

 **NOTE:** Double insulated tools are equipped with a polarized plug (one blade is wider than the other). This plug will fit in a polarized outlet only one way. If the plug does not fit fully in the outlet, reverse the plug. If it still doesn't fit, contact a qualified electrician to install a polarized outlet. Do not change the plug in any way.

 **WARNING:** To reduce the risk of electric shock, DO NOT use in damp conditions, on wet surfaces, or expose to rain. Do not plug in this tool or operate it with wet hands or while standing in water.

 **WARNING:** Always remove the power cord from the electric outlet when making adjustments, changing parts, cleaning or working on the tool.

 **WARNING:** Never attempt to plug in or operate equipment with defective or damaged wires, power cord or power cord plug. Have any defective or damaged parts replaced immediately by qualified personnel.

 **WARNING:** Avoid body contact with electrically grounded surfaces. There is an increased risk of electric shock if your body is grounded.

## Inverter Safety Warnings

 **WARNING:** Read all the Cautions and Warnings before installing and using the power inverter. The inverter must be properly installed. If you are not familiar with 12-Volt high current wiring, it is recommended that you have a professional automotive installer install the inverter. Failure to follow all warnings and instructions may result in electric shock, fire and/or serious injury or death.

 **WARNING:** The power inverter generates 115V AC power from your 12-Volt car battery. Treat the 115V AC output just like you treat the 115V AC in your house. Keep children away from the unit.

 **WARNING:** ATD Tools, Inc. does not authorize or recommend this inverter or any related products to be used with life support devices or systems.

## Inverter Safety Warnings (Continued)

 **WARNING:** With use, the inverter will become warm and possibly hot. Keep it away from any heat sensitive materials. Make sure the inverter is not close to any potential source of flammable fumes, gases or clothing. Keep the unit away from flammable material or in any location which may accumulate flammable fumes or gases, such as the battery compartment of your car, boat, RV or truck.

 **WARNING:** Do not operate the unit in an enclosed area that contains automotive type lead-acid batteries. This type of battery emits explosive hydrogen gas that can be ignited by sparks.

 **WARNING:** Do not use the inverter near an open engine compartment.

 **WARNING:** Keep the inverter dry. DO NOT allow the inverter to come into contact with rain or moisture. DO NOT operate the inverter if you, the inverter, the device being operated or any other surfaces that may come in contact with any power source are wet. Water and many other liquids can conduct electricity, which may lead to serious injury.

 **WARNING:** Do not connect the unit to AC distribution wiring.

 **WARNING:** Only connect the power inverter to a 12-Volt battery accessory outlet or 12-Volt battery. Make sure the AC plug connection is tight. Do not modify the AC receptacle in any way.

 **WARNING:** Do not place the inverter in direct sunlight. Keep the unit in cool environments. The ideal air temperature for operation is between 50° and 80° F. Keep out of direct sunlight and away from heating vents, radiators or other sources of heat. Keep the inverter well ventilated in order to properly disperse heat generated while it is in use. Make sure there are several inches of clearance around the top and sides and do not block the slots of the inverter.

 **WARNING:** Do not open the unit. High voltages are present inside.

 **WARNING:** Use proper size wiring. High power inverters can draw many amps from the 12-Volt source and can melt wires if not fused and sized properly.

 **WARNING:** Some chargers for small nickel-cadmium batteries can be damaged if connected to the unit. Do not use the unit on small battery-operated appliances such as flashlights, razors and night lights that can be plugged directly into an AC outlet to recharge. Also do not use the unit on certain battery chargers for battery packs used in hand power tools. These chargers will have a warning label indicating that dangerous voltages are present at the battery terminals.

 **WARNING:** This device does not include an internal Ground Fault Circuit Interrupter (GFCI).

## **Getting Started**

When you turn on an appliance or a tool that operates using a motor or tubes, it requires an initial surge of power to start up. This surge of power is referred to as the "starting load" or "peak load". Once started, the tool or appliance requires less power to continue to operate. This is referred to as "continuous load" in terms of power requirements. You will need to determine how much power your tool or appliance requires to start up (starting load) and its continued running power requirements (continuous load). Power consumption is rated either in wattage (watts) or in amperes (amps) and this information is usually stamped or printed on most appliances and equipment. If this information is not indicated on the appliance or equipment, check the owner's manual or contact the manufacturer to determine if the device you are using is compatible with a modified sine wave source.

### **Multiply: AMPS X 110 (AC voltage) = WATTS**

This formula yields a close approximation of the continuous load of your appliance

### **Multiply: WATTS X 2 = Starting Load**

This formula yields a close approximation of the starting load of your appliance. Most often the start up load of the appliance or power tool determines whether your inverter has the capability to power it.

To determine whether the inverter will operate a particular piece of equipment or appliance, run a test. The inverters are designed to automatically shut down in the event of a power overload. This protection feature prevents damage to the unit while testing appliances and equipment with ratings in the 1500-Watt range.

If an appliance in the 1500-Watt range will not operate properly when first connected to the inverter, turn the inverter rocker switch ON, OFF, and ON again in quick succession. If this procedure is not successful, it is likely that the inverter does not have the required capacity to operate the appliance in question.

### **Important**

- The inverter is designed to operate from a 12-Volt power source only. Do not attempt to connect the inverter to any other power source, including any AC power source.
- Do not attempt to extend or otherwise modify the 12-Volt power cord attached to your inverter.
- 110 volts of current can be lethal. Improper use of your inverter may result in property damage, personal injury or loss of life.

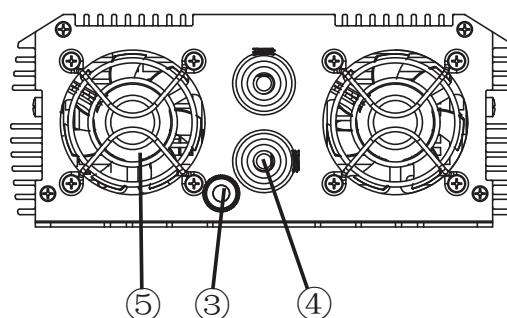
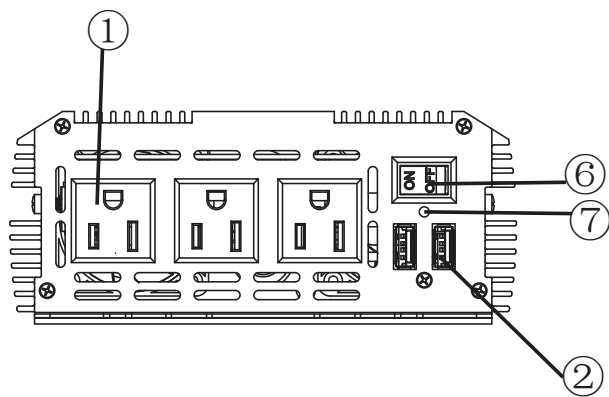

- ① AC outlets
- ② USB ports
- ③ Ground terminal
- ④ DC input “+” terminal (red)  
DC input “-” terminal (black)

- ⑤ Cooling fan
- ⑥ ON / OFF Switch
- ⑦ Power indicator (green)

Battery Terminal Cable

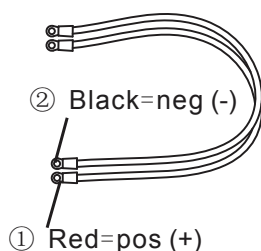

Ground Wire (yellow and green)



## Connecting Your Inverter

1. Make sure the ON/OFF rocker switch located on the front panel of the inverter is in the OFF (0) position.
2. Connect the red terminal of the 12V DC input cable to the “+” terminal and tighten the lug. Connect the black terminal of the 12V DC input cable to the “-” terminal and tighten the lug. **DO NOT REVERSE THESE WIRES!** Connect the other ends of these wires to their corresponding battery terminals or power points in the vehicle.
3. Turn the inverter rocker switch to the ON position. The GREEN LED Indicator light should glow, confirming that there is power running to the inverter.
4. Confirm that the appliance to be operated is turned OFF. Turn the inverter rocker switch to the OFF position. Plug the appliance into the AC receptacle on the front panel of the inverter.
5. Turn the inverter rocker switch to the ON position. Turn the equipment or appliance on.
6. If your inverter is not mounted to a grounded surface, be sure to ground the inverter with the ground (yellow and green) wire, connected to the inverter ground terminal and clamped to a grounded surface.



### Note

- Use of an extension cord from the inverter to the appliance or equipment being operated will not significantly decrease the power being generated by the inverter. For best operating results, the extension cord should be no more than 50 feet long.
- If the green LED blinks when you first turn the inverter ON, this indicates that there is a short circuit within the power supply. Turn the inverter OFF. Disconnect the power cables, check connections and reconnect your power cables and then turn the inverter ON again. If this does not remedy the problem try using a different 12-Volt power source.

## **Television and Audio Suggestions**

Although these inverters are shielded and filtered to minimize signal interference, some interference with your television picture may be unavoidable, especially with weak signals. However, here are some suggestions that may improve reception.

1. First, make sure that television antenna produces a clear signal under normal operating conditions (i.e., at home plugged into a standard 110V AC wall outlet). Also, ensure that the antenna cable is properly shielded and of good quality.
2. Change the positions of the inverter, antenna cables and television power cord.
3. Isolate the television, its power cord and antenna cables from the 12-Volt power source by running an extension cord from the inverter to the television set.
4. Coil the television power cord and the input cables running from the 12-Volt power source to the inverter.
5. Attach a "Ferrite Data Line Filter" to the television power cord. More than one filter may be required. These filters are available at most electronic supply stores.



### **Note**

- Inexpensive sound systems may emit a "buzzing" sound when operated with the inverter. This is due to inadequate filters in the sound system. There is no solution to this problem short of purchasing a sound system with a higher quality power supply.

## **Blown Automotive Fuses**

Depending on the make and model of your automobile, running the power inverter near full capacity may result in a blown automotive fuse. This fuse will need to be replaced with the same size fuse. Please note, a blown automotive fuse will not cause damage to your car wiring.

## **Blown Power Inverter Fuses**

Your power inverter is equipped with (6) internal 30A spade-type fuses. With reasonable care it should not be necessary to replace these fuses. Most blown fuses are the result of reverse polarity or a short circuit within the appliance or equipment being operated. If the fuse happens to blow, disconnect the appliance or equipment immediately, find the source of the problem, repair it and replace the fuse in question. To replace the fuse(s), first turn the unit off and disconnect the inverter from your 12V DC power source. Once power is disconnected, turn the power switch to the "on" position for one minute to discharge the unit, then turn it off again. Remove four screws from the corners of the back of the unit, slide the fan panel slightly out of the way in order to slide the bottom panel out and reveal the fuses. Using insulated needle nose pliers and being careful not to disturb other components, pull the fuse out and replace it with a good fuse. Slide bottom panel back into place, and secure the fan panel with the four screws.

## **Source of Power**

Most automobile and marine batteries will provide an ample power supply to the inverter for 30 to 60 minutes even when the engine is off. Actual time may vary depending upon the age and condition of the battery, and the power demand being placed on it by the equipment being operated with the inverter. If you decide to use the inverter while the engine is off, we recommend that you start the engine every hour and let it run for approximately 10 minutes to recharge the battery. We also recommend that the device plugged into the inverter be turned OFF before starting the vehicle engine. Although it is not necessary to disconnect the inverter when turning over the engine, it may momentarily cease to operate as the battery voltage decreases. When the inverter is not supplying power, it draws very low amperage from the battery and may be left connected to the battery for up to three hours. However, we recommend the inverter always be disconnected when not in use.



## Inverter Protection Features

- This inverter has protection against input under voltage, input over voltage, overload, excessive temperature and short circuiting. In any of the above occurrences, the inverter will shut down and after the problem has been corrected, the inverter can be restarted.



### **Note**

- The inverter is equipped with a cooling fan which is designed to save energy by only running when the load exceeds 30% of the power of the inverter OR when the inside temperature of the inverter exceeds 140°F (60°C) .

## How Power Inverters Work

There are two stages in which a power inverter changes the 12-volt DC (or battery) power into 110V AC (household current).

### **STAGE 1:**

The inverter uses a DC-to-DC converter to increase the DC input voltage from the power source to 145 volts DC.

### **STAGE 2:**

The inverter then converts the high voltage DC into 110V AC (household current), using advanced MOSFET (Metal-oxide-Semiconductor Field Effect Transistor) transistors in a full bridge configuration. This design provides all our inverters with the capability to start and run difficult reactive loads, while providing excellent overload capability. The waveform that is generated by this conversion is a "modified sine wave" as shown in the diagram below.

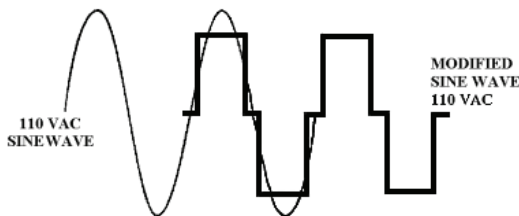

The modified sine wave produced by our inverters has a root mean square (RMS) voltage of 110 volts. The majority of AC voltmeters are calibrated for RMS voltage and assume that the measured waveform will be a pure sine wave. Consequently, these meters will not read the RMS modified sine wave voltage correctly and, when measuring the inverter output, the meters will read about 20 to 30 volts too low. To accurately measure of the output voltage of the inverter, use a true RMS reading voltmeter such as a Fluke 87, Fluke 8060A, Beckman 4410, Triplet 4200 or any multimeter identified as "True RMS"

## In Review

- Never attempt to operate the inverter from any power source other than a 12-Volt DC battery.
- This inverter is designed to be connected to the power source with the supplied power cables. Do not attempt to modify the cables, or use the cigarette lighter socket as a power source.
- While connecting the inverter to the power source, make certain that the inverter is positioned far away from any potential source of flammable fumes or gases,
- Make certain the power consumption of the appliance or equipment you wish to operate is compatible with the capacity of the inverter. **Do not exceed 1500-Watts.**
- When attempting to operate battery chargers, monitor the temperature of the battery charger for approximately 10 minutes. If the battery charger becomes abnormally warm, disconnect it from the inverter immediately.
- Use only 30A spade-type fuses.
- When operating the inverter with an automobile or marine battery, start the engine every 30 to 60 minutes and let it run for approximately 10 minutes to recharge the battery.
- In the event of a continuous audible alarm or automatic shut down, turn the inverter OFF immediately. Do not restart the inverter until the source of the problem has been identified and corrected.
- To avoid battery drain, always disconnect the inverter when not in use.
- Do not expose the inverter to rain or moisture.
- Avoid placing the inverter near sources of heat or in direct sunlight.
- While in use, make sure the inverter is properly ventilated.
- Do not operate the inverter near flammable materials, fumes or gases.

# TROUBLESHOOTING GUIDE

TROUBLE/INDICATION	POSSIBLE CAUSE	SUGGESTED REMEDY
NO AC OUTPUT - RED LED LIT	DC INPUT BELOW 10 VOLTS	RECHARGE OR REPLACE BATTERY
	DC INPUT ABOVE 15 VOLTS	REDUCE CHARGING VOLTAGE
	EXCESSIVE LOAD - THERMAL SHUTDOWN	REDUCE LOAD, WAIT FOR INVERTER TO COOL. TURN OFF, THEN TURN ON
NO AC OUTPUT - GREEN LED NOT LIT	INVERTER FUSE(S) BLOWN	CHECK DC INPUT FUSES IN VEHICLE, REPLACE IF FUSE IS BLOWN. REMOVE FUSE(S) AND REPLACE WITH SAME TYPE AND RATING
LOW BATTERY ALARM SOUNDS CONTINUOUSLY	BAD CONNECTION OR WIRING. LOW BATTERY VOLTAGE	TIGHTEN ALL DC CONNECTIONS. RECHARGE BATTERY. REMOVE LOAD FROM INVERTER WHILE CHARGING BATTERY
RED LED FLASHES	PURELY INDUCTIVE LOAD	MAKE THE LOAD NOT PURELY INDUCTIVE BY OPERATING AN INCANDESCENT LIGHT AT THE SAME TIME AS THE MOTOR
OVER HEAT	THERMAL PROTECTION	INTERNAL TEMPERATURES ARE TOO HIGH. ALLOW INVERTER TO COOL FOR AT LEAST 30 MINUTES. ENSURE THAT FAN IS NOT BLOCKED AND THAT THERE IS PROPER VENTILATION
MOTORIZED POWER TOOL WON'T START OR RUN AT CORRECT SPEED	EXCESSIVE START-UP CURRENT. PUMPS, COMPRESSORS AND ELECTRIC MOTORS CAN CAUSE THIS	IF APPLIANCE DOES NOT START, THEN THE APPLIANCE IS NOT COMPATIBLE WITH THE INVERTER, DISCONTINUE USE
SNOW IN PICTURE (TV), BUZZ IN SPEAKERS (ANY AUDIO)	TELEVISION/RADIO INTERFERENCE	KEEP INVERTER AND ANTENNA DISTANT FROM EACH OTHER. USE SHIELDED ANTENNA CABLE AND INLINE SIGNAL FILTERS

- USE THIS UNIT IN PROPERLY VENTED AREAS ONLY
- DO NOT INSTALL IN COMPARTMENTS OR AREAS CONTAINING FLAMMABLE MATERIALS OR VAPORS.
- DO NOT EXPOSE TO WATER OR DAMP ENVIRONMENTS
- WHEN CONNECTING BATTERY CLIPS DIRECTLY TO BATTERY, BE SURE TO MATCH CORRECT POLARITY OR DAMAGE TO UNIT WILL OCCUR, VOIDING WARRANTY.

**SPECIFICATIONS**

Max. Continuous Power.....1500-Watts  
 Surge Capability (Peak Power) .....3000-Watts  
 No Load Current Draw .....1A  
 Waveform .....Modified Sine Wave  
 Input Voltage Range .....11-14V DC  
 AC Receptacles .....110V AC 3-prong grounded  
 Fuse .....30A (x6)  
 Dimensions.....10.12" x 6.50" x 2.72" (257mm x 165mm x 69mm)  
 Weight.....5.8 lbs. (2.6 kg)

**Digital Readout**

Your ATD-5954 unit is equipped with a seven segment, LED, digital readout that will alternate between “V” and “P”. “V” indicates the power input from your DC voltage source, while “P” indicates the power being used by your appliance or equipment.

**Power Cord Specification**

- 1 set 6 AWG 30” battery terminal cables (black and red)
- 1 set 18 AWG 41” ground wire (yellow and green)

**Inverter Cables**

400W & 800W inverters come with a 12V DC outlet (cigarette lighter) plug.  
 800W can and 1500W-3000W inverters **MUST** be hard-wired to the battery.  
 When hard-wiring the inverter to the battery, **USE THE THICKEST WIRE AVAILABLE IN THE SHORTEST LENGTH PRACTICAL**

Wattage	Length	Length	Length	Length	Length
	0"-18.9" (0-48 cm)	0"-29.5" (0-75 cm)	0"-31.5" (0-80 cm)	0"-48" (0-122 cm)	59"-120" (150-305 cm)
800W	#9 AWG		#8 AWG		#6 AWG
1500W	#6AWG		#5 AWG		#4 AWG
3000W	#6 AWG	#5 AWG			#4 AWG



## WARRANTY

### 1 YEAR LIMITED WARRANTY

THIS WARRANTY AND CONFIRMED RECEIPT(S) SHOULD BE RETAINED BY THE CUSTOMER AT ALL TIMES

PURCHASED FROM: \_\_\_\_\_

DATE PURCHASED: \_\_\_\_\_

INVOICE/RECEIPT NUMBER: \_\_\_\_\_

Your ATD-5954 is warranted for a period of 12 months from the original purchase date.

For a period of one (1) year from your purchase date, ATD Tools Inc. will repair or replace (at its option) without charge, your ATD product if it was purchased new and the product has failed due to a defect in material or workmanship which you experienced during normal use of the product. This limited warranty is your exclusive remedy.

To access the benefits of this warranty, contact your supplier, or point of sale directly. You may be advised to return the product under warranty, freight prepaid, to your supplier for warranty determination.

If this ATD product is altered, abused, misused, modified, or undergoes service by an unauthorized technician, your warranty will be void. We are not responsible for damage to ornamental designs you place on this ATD product and such ornamentation should not cover any warnings or instructions or they may void the warranty. This warranty does not cover scratches, superficial dents, and other abrasions to the paint finish that occur under normal use. It also does not cover normal wear items such as but not limited to brushes, batteries, drill bits, drill chucks, pads or blades.

Subject to the law in your state:

- (1) Your sole and exclusive remedy is repair or replacement of the defective product as described above.
- (2) ATD is not liable for any incidental damages, including but not limited to, lost profits and unforeseeable consequences.
- (3) The repair and replacement of this product under the express limited warranty described above is your exclusive remedy and is provided in lieu of all other warranties, express or implied. All other warranties, including implied warranties and warranties of merchantability or fitness for a particular purpose are disclaimed and, if disclaimer is prohibited, these warranties are limited to one year from your date of purchase of this product.

Some states' laws do not allow limited durations on certain implied warranties and some states' laws do not allow limitations on incidental or consequential damages. You should consult the law in your state to determine how your rights may vary.

[Affix receipt or invoice here for safe keeping]