



This unit must be fully charged every 2-3 months whether used or not

ATD-5926 RECHARGEABLE 12 VOLT 22 AMP/HOUR JUMP START WITH BUILT IN 260 PSI AIR COMPRESSOR OWNERS MANUAL



- 1700 peak amps/400 cranking amps of starting power.
- Starts cars, trucks, RV's and boats without the need of another vehicle or AC power cords.
- 12V DC socket with overload protection provides power for any 12V appliance.
- Provides up to 50-hours of DC power when used with 12V DC appliances.
- Allows 12V DC appliances to be used in remote sites and/or in emergencies when commercial power is not available.
- Solid-state, automatic operation and circuit protection.
- Requires no maintenance for optimum operation.
- Sealed, maintenance-free, heavy-duty battery is safe to use and transport.
- Can be stored in any position without risking acid leakage.
- 43" heavy-duty 4 gauge copper cables can carry more amperage than similar units.
- Easy to read color coded battery meter.
- Built-in converter allows recharging from any 120V AC power source.
- DC power cord allows recharging from 12V DC socket.
- 260 psi maximum pressure built-in air compressor with 29" hose and locking air chuck, plus (3) accessory fittings
- Integrated work light for roadside vehicle repairs or emergency situations away from commercial power.
- Heavy-duty impact resistant polyethylene case
- External 120V AC/12V DC charging adapter with an automatic cut-off to prevent overcharging.
- Molded high-impact case is tough and durable.





Made in China to ATD Specifications
Visit us at www.atdtools.com

California Prop 65 WARNING:

Batteries contain lead and other chemicals known to the State of California to cause cancer, birth defects and other reproductive harm. **Wash hands after handling.**

General Safety Warnings:

 **WARNING:** The instructions and warnings contained in this manual should be read and understood before using or operating this tool. Do not allow anyone to use or operate this tool until they have read this manual and have developed a thorough understanding of how this tool works. Failure to observe any of the following instructions could result in severe personal injury to tool user and bystanders, or cause damage to the tool and property. Keep this manual for future reference.

 **Note:** The warnings and cautions discussed in this instruction manual cannot cover all possible conditions and situations that may occur. It must be understood by the operator that common sense and caution are factors which cannot be built into this product, but must be supplied by the operator.

 **WARNING:** Use safety equipment. Users and bystanders should use safety goggles or safety glasses with side shields which comply with current national standards, or when needed, a face shield. Use an ANSI approved dust mask or respirator when working around metal, wood, and chemical dusts and mists. This applies to all persons in the work area. Also use non-skid safety shoes, hardhat, gloves, dust collection systems, and hearing protection when appropriate.

 **WARNING:** Keep bystanders and children out of the work area while operating this tool.

 **WARNING:** Always keep your work area clean, uncluttered, and well lit. Cluttered or dark areas invite accidents and injuries. DO NOT work on floor surfaces that are slippery.

 **WARNING:** Do not operate this tool if you are tired or under the influence of alcohol, drugs, or medications that could affect your ability to use the tool properly.

 **WARNING:** Dress properly. Do not wear loose clothing or jewelry as they can be caught in moving parts. Wear restrictive hair covering to contain long hair.

 **WARNING:** Do not reach over or across running machines. Keep proper footing and balance at all times. Non-skid footwear is recommended when working.

Lead Acid Battery Safety Warnings:

 **WARNING:** WORKING AROUND LEAD-ACID BATTERIES MAY BE DANGEROUS.

- Lead-acid batteries release explosive gases during normal operation, charging and jump starting.
- All lead-acid batteries (car, truck and boat) produce hydrogen gas which may violently explode in the presence of fire or sparks. **Do not smoke, use matches or a cigarette lighter while near batteries.** Only work with lead-acid batteries in a well-ventilated area. Do not handle the battery while wearing vinyl clothing because static electricity sparks are generated when vinyl clothing is rubbed.
- To reduce risk of battery explosion, follow these instructions and those published by the battery manufacturer and manufacturer of any equipment you intend to use in the vicinity of the battery. Review cautionary markings on these products and on engine.

EYE PROTECTION:

- User and bystanders should always wear eye protection, appropriate protective clothing and other safety equipment when working near lead-acid batteries. Do not touch eyes while working on or around lead-acid batteries.
- **IF SPLASHED WITH BATTERY ACID, IMMEDIATELY FLUSH AFFECTED AREA SUCH AS FACE AND PARTICULARLY THE EYES WITH CLEAN WATER.** Seek medical attention and continue flushing face and eyes until medical help arrives.

WORKING IN ENGINE COMPARTMENT:

- Use extreme caution while working within the engine compartment, because moving parts may cause severe injury. Read and follow all safety instructions published in the vehicle's Owner's Manual.

GENERAL PRECAUTIONS / PERSONAL PRECAUTIONS:

- Never work alone with lead-acid batteries. Make sure that someone is around to give assistance if you need help.
- Wear complete eye protection and clothing protection. Avoid touching eyes while working near battery.
- In case of battery acid contact with eyes, skin or clothing, always have soap and water near your work area.
- Remove jewelry such as rings, bracelets, necklaces and watches when working around a battery. A lead-acid battery can produce a short circuit current, which can melt metals and result in a severe burn.
- Do not drop tools or other metal objects on or near the battery as a spark may result, igniting explosive gases.
- Never jump start or attempt to recharge a frozen battery.

Electrical Safety Warnings:

 **WARNING:** Read all safety warnings and instructions. Failure to follow all warnings and instructions may result in electric shock, fire and/or serious injury or death.

 **WARNING:** To reduce the risk of electric shock, DO NOT use in damp conditions, on wet surfaces, or expose to rain. Do not plug in this jump start or operate it with wet hands or while standing in water.

 **WARNING:** Never use the cords or cables for carrying, pulling or unplugging your jump start. Grasp plug and pull to disconnect charger from outlet. Keep cord away from heat, oil, sharp edges or moving parts. Replace damaged cords immediately.

 **WARNING:** Always remove the charger from the electric outlet when making adjustments, changing parts, cleaning or working on the tool.

 **WARNING:** Care should be taken to arrange the cords and cables so they will not be stepped on, tripped over, or otherwise subjected to damage or stress.

 **WARNING:** Never attempt to plug in or operate equipment with defective or damaged wires, charger cord or charger cord plug. Have any defective or damaged parts replaced immediately by qualified personnel.

 **WARNING:** Avoid body contact with electrically grounded surfaces. There is an increased risk of electric shock if your body is grounded.

 **WARNING:** If the work area is not equipped with a permanently installed Ground Fault Circuit Interrupter outlet (GFCI), use a plug-in GFCI between the charging cord and the power receptacle.

ATD-5926 Specific Warnings:

 **WARNING:** Lead-acid batteries generate hydrogen gas during normal operation. More gas is generated when the battery is charging. Hydrogen gas is:

- 1. Explosive*
- 2. Poisonous to breathe*
- 3. Highly flammable*

 **WARNING:** To avoid possible damage that may shorten the units working life, protect this unit from direct sunlight, direct heat, and /or moisture.

 **WARNING:** This system is designed to be used only on vehicles or boats with 12-volt electrical systems.

 **WARNING:** This system is not designed to be used as a replacement for a vehicle battery.

 **WARNING:** To avoid an explosion and/or the possibility of being splashed with battery acid:

- Never allow the red and black clamps to touch each other or for both to touch the same metal object or any electrically conductive material for that matter.
 - Only attempt to jump start a vehicle or boat in a well-ventilated area.
 - Always connect the red (+) clamp to the positive (+) battery terminal first.
 - Do not connect the black (-) clamp to the negative (-) battery terminal.
 - Connect the black (-) clamp to a non-moving metal part on the engine not to the negative (-) battery terminal.
-

INTRODUCTION

Your power pack unit is designed as a compact, durable and portable jump start system for 12 volt DC vehicles and boats. This self-contained system will start most vehicles and boats without the need for a host vehicle or 120V AC power supply. This system can also be used as a safe, portable source of 12V DC electric power in remote locations and/or in emergencies.

The power pack unit has an easy-to-read, color-coded battery meter that indicates charge level. A 12V DC socket is provided for use with appliances that would operate from a vehicles cigarette lighter or 12V DC socket. This allows maximum portability and utility when your power pack unit is used in remote locations.

For maximum convenience, your power pack unit can be recharged from a 120V AC power source. The built-in 500mA recharger/converter has an automatic cut-off that prevents over charging the battery. A black rocker switch operates the built-in lamp. A red rocker switch shows the battery condition on the meter. A covered 12V DC socket is provided, as well as a covered receptacle for a 120V AC power recharging cord. The red light emitting diode (led) illuminates when the system is recharging.

Note: on/off switch only controls power to the 2 battery clamps. We suggest you keep this switch in the "off" position for all operations other than jump starting a car.

RECOMMENDATIONS FOR GETTING THE MOST FROM YOUR NEW POWER PACK UNIT

RECHARGING:

1. For maximum battery life, we recommend that your power pack unit be kept fully charged at all times. If the battery is allowed to remain in a discharged state, battery life will be shortened. Table 1 shows the relationship of the frequency of use between recharging and the expected number of charge/recharge cycles.

TABLE I. - BATTERY LIFE	
NUMBER OF JUMP-STARTS BETWEEN RECHARGING	DISCHARGE AND RECHARGE CYCLES
1	1000+
5	700+
10	500+

2. The time required to fully recharge your power booster after jump-starting an engine is a function of how many jump-starts are performed between recharging sessions. Table 2 shows the approximate recharging times you can expect.

Table II. - RECHARGING TIMES vs. JUMP STARTS			
Number Of Jump-Starts	Recharging Time (In Hours)	Number Of Jump-Starts	Recharging Time (In Hours)
1	8	4	32
2	16	5	40
3	24	6	48

3. Check the charge in your power pack unit often by depressing the red push-button switch. The meter will show the battery charge.

120V AC CHARGING:

Plug the 120V AC/12V DC charging adapter into a wall outlet and into the receptacle on your new power pack unit. Charge this device for at least 4 hours or until the meter shows a full (14- to 15-V DC) charge when the red rocker switch is depressed. The recharging converter circuit unit has an automatic cut-off circuit so the internal battery cannot be overcharged. To recharge your power pack unit battery from 120V AC follow these steps:

1. On the power packs right side, there are two receptacles, one is round and one is rectangular.
2. Pull the plug cover from the rectangular receptacle out, exposing two prongs of a standard 120V AC power cord. A restraint keeps the plug cover from getting lost. The plug cover is important to maintain the weather-resistant integrity of your power pack unit.
3. One of the power cords furnished with your power pack has a standard 120V AC male plug at one end, and a rectangular two prong receptacle at the other end. Plug this power cord into the rectangular receptacle on the side of the unit and plug the other end into your 120V AC outlet. The red LED will illuminate indicating charging is in process.
4. Continue to charge until the voltmeter indicates full capacity in green area when the test button is pressed.
Important: do not stop charging before the meter indicates full capacity in green area.

At this point, once the charger is disconnected, the voltage will slowly settle back to read 100%. This is quite normal and indicates that the battery is at full capacity. **Note:** to fully charge a battery could take up to 72 hours, depending upon the state of discharge. The unit can remain plugged into the power socket indefinitely as the internal PCB has an automatic "float charging circuit" which will not allow an overcharge condition or damage to the battery.

12V DC CHARGING:

Your new power pack unit is equipped with a receptacle that will allow you to re-charge this system from the 12V DC socket in your vehicle or boat.

Note: We recommend that you use the 12V DC recharging procedure only when necessary, as continued use of the 12V DC recharging procedure may shorten the system's life. To use the 12V DC recharging system:

1. Insert the power cord with the 12V DC plug into the 12V DC receptacle on your vehicle or boat.
 2. Insert the plug at the other end of this power cord into the receptacle on the side of your power booster.
Charge this device for at least 4 hours or until the meter shows a full (14- to 15-V DC) charge when the red rocker switch is depressed. Unlike the AC charging circuit, there is NO FLOATING CHARGE circuit on the DC charging outlet. It is HIGHLY recommended that DC charging only be used in emergency cases.
-

OPERATION

To use your power pack unit as a 12V DC power source:

1. Lift up the cover of the 12V DC receptacle on the side of your jump pack.
2. Insert the 12V DC plug from the appliance into the 12V DC receptacle.

Note: on/off switch can be left in the "off" position.

Table III will give you an idea of what operation time to expect when starting from a fully charged system:

Table III. - POWER PACK AS A 12V DC POWER SOURCE		
<i>Appliance Type</i>	<i>Estimated Power Consumption (In Watts)</i>	<i>Estimated Usage Times (In Hours)</i>
Fluorescent Lights, Cell Phones	4	30
Radios, Fans, Depth Finders	9	21
Camcorders, VCR's, Spotlights	15	12
Electric Tools, Bilge Pumps	24	7
Electric Coolers	48	3
Air Compressors, Car Vacuums	80	1.5

Table IV will give you an idea of what operation time you can expect when starting from a fully charged system. When using your power pack unit as a 120 v ac power source with a power inverter:

Table IV. - POWER PACK AS A 12V DC POWER SOURCE WITH POWER INVERTER		
<i>Appliance Type</i>	<i>Estimated Power Consumption (In Watts)</i>	<i>Estimated Usage Times (In Hours)</i>
Spotlights, Sump Pumps & VCR's	100	1.5
Faxes, TV's, Small Appliances	150	1
Computers, Printers	200	0.75
Medium Power Tools, Blenders	250	0.05

JUMP-STARTING:

For optimum performance, when using your power pack unit to jump start a vehicle or boat, please read and Follow these step-by-step instructions:

1. Switch the engine of the vehicle or boat to be jump-started to "off".
2. Connect the red (+) "alligator" clamp to the red (+) positive battery terminal.
3. Connect the black (-) "alligator" clamp to a non-moving metal part of the engine, **not to the (-) negative battery terminal.**
4. Turn power pack unit switch to "on".
5. Wait a minute or two to let the vehicle battery charge
6. Try to start the vehicle but **do not try for more than 5 to 6 seconds.**
7. If the vehicle or boat engine does not start, wait at least 3 minutes before trying again.

under no circumstances allow the red and black clamps to touch each other or a common conductor

Once the engine is running, **first** disconnect the black (-) clamp and return this cable to its stored position on the power pack unit, **then** disconnect the red (+) clamp and return this cable to its stored position on the power pack unit. As soon as possible, connect your power pack unit system to 120-vac and recharge.

USING THE AIR COMPRESSOR:

For inflating tires, attache the air hose to the tire by pushing the connector down firmly on the tire adapter and locking in place by turning the connector locking lever 90 degrees.

Switch on the compressor. The gauge will indicate the air pressure.

 **WARNING:** THE AIR COMPRESSOR GAUGE ON THIS PRODUCT IS FOR GUIDANCE ONLY. IT IS IMPORTANT THAT YOU CHECK YOUR TIRE PRESSURE WITH AN APPROVED GAUGE.

Three adaptors are also provided which allow the compressor to be used for inflating air beds, footballs, etc. Select the appropriate adapter and push the threaded end firmly into the air hose connector, locking it in place by turning the connector locking lever 90 degrees.

 **WARNING:** DO NOT RUN THE AIR COMPRESSOR FOR MORE THAN TEN MINUTES AT A TIME. ALLOW A TEN MINUTE PERIOD TO ELAPSE BEFORE SWITCHING THE COMPRESSOR ON AGAIN.

BATTERY REPLACEMENT

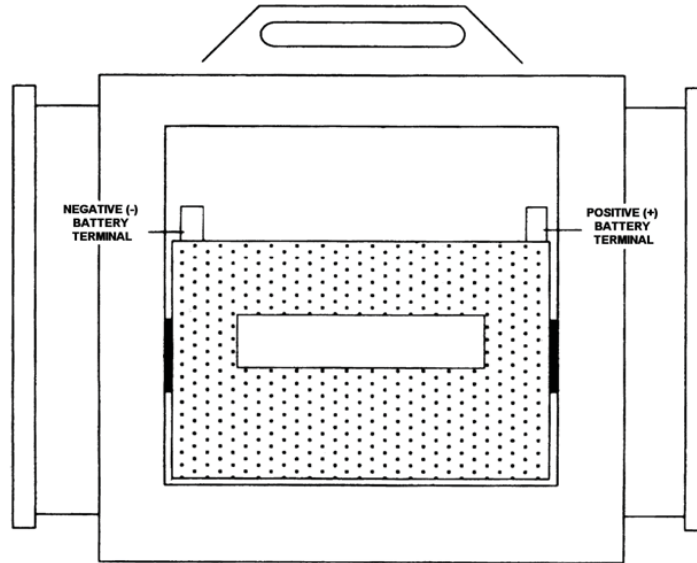

FIGURE 1. - Rear view of the power pack unit showing the battery compartment

1. Unscrew and remove the Phillips head screws that hold the rear cover in place on the back of your power pack unit.
2. Lift off the cover plate to expose the battery compartment.
3. Lift the battery out of the battery compartment.
4. Detach the #4 jumper cables and the red and black recharging wires from the battery terminals.
5. Ensure that the replacement battery is oriented with the positive on the right side and the negative on the left side, just as the old battery came out.
6. Connect the red #4 jumper cable and red recharging wire to the positive (+) battery terminal (also marked with red), then connect the black #4 jumper cable and recharging wire to the negative (-) battery terminal. Double check all connections, and tighten.
7. Taking care not to damage the circuit board, slide the new battery in position.
8. Replace the battery compartment cover and secure in place with the Phillips head screws.

SPECIFICATIONS

ITEM #ATD-5926
VOLTAGE12V DC
BOOST POWER400 CRANKING AMPS
PEAK AMPS.1700 AMPS
BATTERY TYPESEALED, LEAD- ACID, RECHARGEABLE, MAINTENANCE-FREE, 12V DC, 22-AMP-HOURS
BOOSTER CABLES43", #4 GAUGE 100% COPPER CABLES WITH 500 AMP "ALLIGATOR" CLAMPS
AIR COMPRESSOR.260 PSI
DIMENSIONS 11.8" x 10.6" x 3.5" (30 x 27 x 9 CM)



ATD-5926

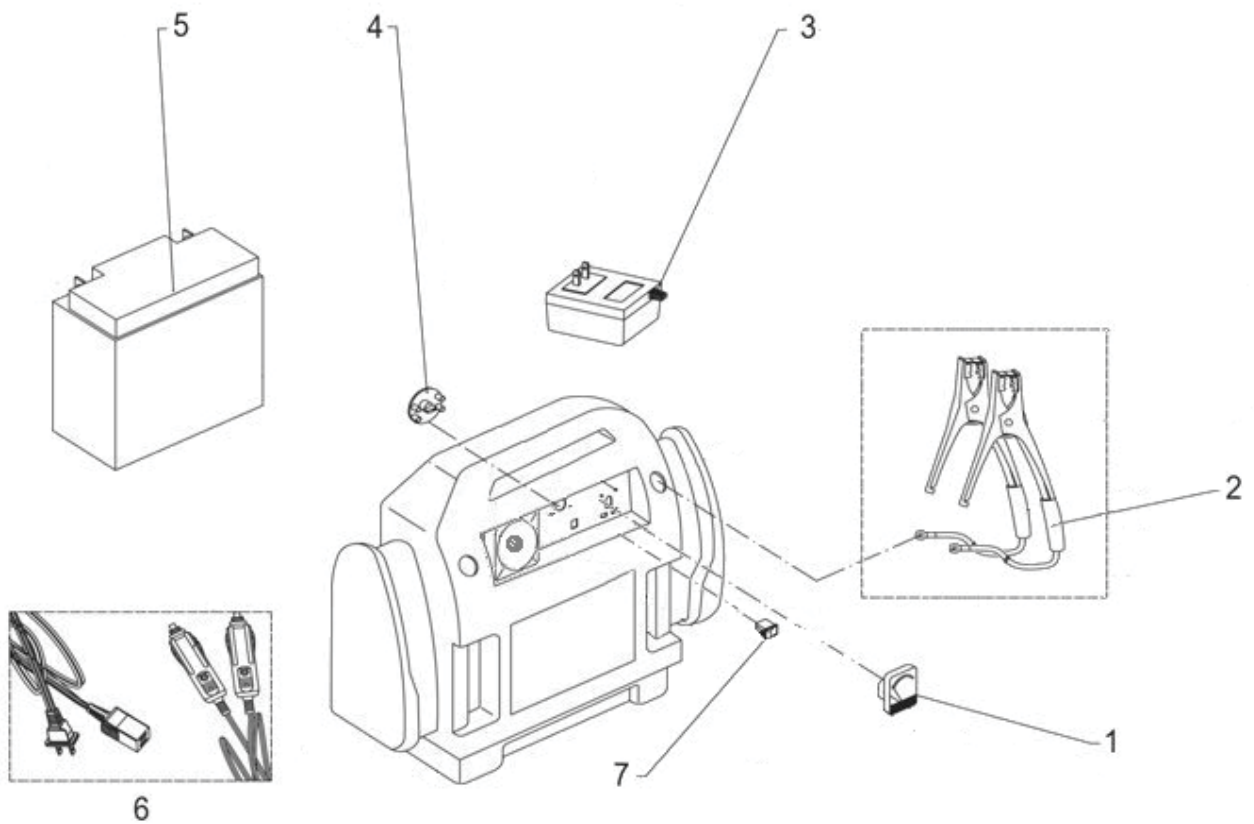

ITEM#	ORDERING PART#	PART DESCRIPTION
1	247-926-666	VOLTMETER
2	238-922-666	JUMP CABLE SET
3	865-922-666	TRANSFORMER 500mA
4	246-922-666	ON/OFF SWITCH
5	235-013-666	12V/22AH BATTERY
6	238-926-666	AC & DC POWER CORDS
7	246-926-666	TEST SWITCH

LIMITED WARRANTY

Manufacturer warrants this product to be free from defects in material or workmanship for a period of one year from the date of original end user purchase. This warranty extends to each person who acquires lawful ownership within one year of the original retail purchase, but is void if the product has been abused, altered, misused or improperly packaged and damaged when returned for repair.

This warranty applies to the product only and does not apply to any accessory items included with the product which are subject to wear from usage; the replacement or repair of these items shall be at the expense of the owner.

THE TERMS OF THE LIMITED WARRANTY CONSTITUTE THE BUYER'S SOLE AND EXCLUSIVE REMEDY. IMPLIED WARRANTIES OF MERCHANTABILITY AND FITNESS FOR A PARTICULAR PURPOSE ARE LIMITED IN DURATION TO THIS EXPRESS WARRANTY. AFTER 1 YEAR FROM DATE OF PURCHASE, ALL RISK OF LOSS FROM WHATEVER REASON SHALL BE PUT UPON THE PURCHASER.

MANUFACTURER SHALL NOT BE LIABLE FOR INCIDENTAL OR CONSEQUENTIAL DAMAGES UNDER ANY CIRCUMSTANCES. MANUFACTURER'S LIABILITY, IF ANY, SHALL NEVER EXCEED THE PURCHASE PRICE OF THIS PRODUCT REGARDLESS OF WHETHER LIABILITY IS PREDICATED UPON BREACH OF WARRANTY (EXPRESSED OR IMPLIED), NEGLIGENCE, STRICT TORT OR ANY OTHER THEORY.

Some states do not permit the limitation of warranties or limitation of consequential or incidental damages, so the above disclaimer and limitation may not apply to you. This warranty gives you specific legal rights, and you may also have other rights which vary from state to state.

INSTRUCTIONS FOR OBTAINING SERVICE UNDER THIS WARRANTY:

If this product fails within the first 30 days after retail purchase due to a defect in material or workmanship, return it to your place of purchase for an exchange. From day 31 to day 365 after retail purchase, contact Jump Starter Service at the number below for warranty service.

A valid, dated sales receipt is required to obtain service under this warranty.

**Jump Starter Service
8600 NE Underground Drive
Pillar 248
Kansas City, MO 64161
913.310.1050**