



## 3/16" AIR RIVETER INSTRUCTION MANUAL



### Specifications:

Nosepieces: 3/32", 1/8", 5/32", 3/16"

Rivet Capacity: 3/16"

Motor: 1/2 Hp

Air Inlet Thread NPT: 1/4"

Air Hose I.D. Size: 3/8" (10mm)

Avg. Air Consumption: 4 CFM

Air Pressure: 90-120 psi

Pulling Force: 1984.50 lbs.

**!** **California Prop 65 WARNING:** This product contains chemicals including lead, known to the State of California to cause cancer, birth defects, or other reproductive harm. **Wash hands after handling.**

## General Safety Warnings:

 **WARNING:** The instructions and warnings contained in this manual should be read and understood before using or operating this tool. Do not allow anyone to use or operate this tool until they have read this manual and have developed a thorough understanding of how this tool works. Failure to observe any of the following instructions could result in severe personal injury to tool user and bystanders, or cause damage to the tool and property. Keep this manual for future reference.

 **Note:** The warnings and cautions discussed in this instruction manual cannot cover all possible conditions and situations that may occur. It must be understood by the operator that common sense and caution are factors which cannot be built into this product, but must be supplied by the operator.

 **WARNING:** Use safety equipment. Users and bystanders should use safety goggles or safety glasses with side shields which comply with current national standards, or when needed, a face shield. Use an ANSI approved dust mask or respirator when working around metal, wood, and chemical dusts and mists. This applies to all persons in the work area. Also use non-skid safety shoes, hardhat, gloves, dust collection systems, and hearing protection when appropriate.

 **WARNING:** Keep bystanders and children out of the work area while operating this tool.

 **WARNING:** Always keep your work area clean, uncluttered, and well lit. Cluttered or dark areas invite accidents and injuries. DO NOT work on floor surfaces that are slippery.

 **WARNING:** Do not operate this tool if you are tired or under the influence of alcohol, drugs, or medications that could affect your ability to use the tool properly.

 **WARNING:** Dress properly. Do not wear loose clothing or jewelry as they can be caught in moving parts. Wear restrictive hair covering to contain long hair.

 **WARNING:** Do not reach over or across running machines. Keep proper footing and balance at all times. Non-skid footwear is recommended when working.

---

## Air Tools Specific Safety Warnings:

 **WARNING:** Air under pressure can cause severe injury. Never point an air tool at anyone or direct air at yourself or others. It could cause serious injury.

 **WARNING:** Always turn off the air supply, drain the hose of air pressure and detach the tool from the air supply before installing, removing or adjusting any accessory on this tool, or before performing any maintenance on this tool. Failure to do so could result in injury.

**WARNING:** Always check for damaged, frayed or loose hoses and fittings. Have any defective or damaged parts replaced immediately by qualified personnel.

**WARNING:** Do not carry the tool by the hose. Protect the hose from sharp objects and heat.

**WARNING:** Always use air hose and couplings with a minimum working pressure rating of at least 1-1/2 times the maximum working pressure rating of the tool.

**WARNING:** Do not depress the tool trigger/lever when connecting the air supply hose.

**WARNING:** Do not lock, tape, wire, or otherwise disable the "ON/OFF" valve in the "ON" position. The trigger must always be free to return to the "OFF" position when released.

**WARNING:** When the tool is not in use, shut off the air supply and press the trigger/lever to drain the air supply line. If the tool is not to be used for a period of time, first lubricate, disconnect from the air supply and store in a clean and dry location at average room temperature.



**NOTE:**

### Typical Air Supply Installation

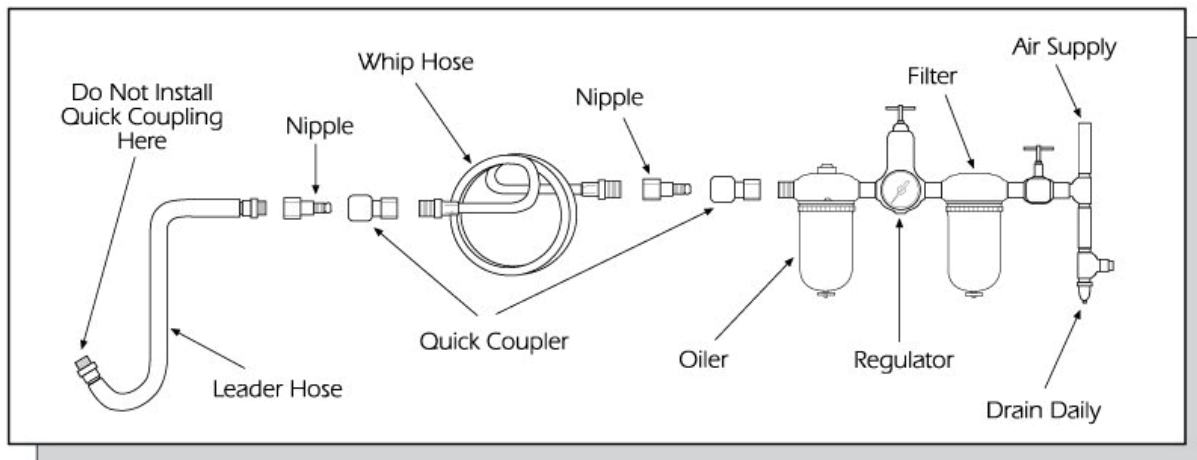

Always use clean, dry air. Dust, corrosive fumes and/or water in the airline will cause damage to the tool. Drain the air tank daily. Clean the air inlet filter screen on at least a weekly schedule. The recommended hook up procedure can be viewed in the above figure. It is recommended to use an ATD-7869, ATD-7872 or similar filter, regulator & lubricator with this tool.

Lubricate the tool's air motor daily with quality air tool oil. If no airline oiler is used, run 1/2 oz. of oil through the tool. The oil can be squirted into the tool air inlet or into the hose at the nearest connection to the air supply, then run into the tool. Overfilling will cause a reduction in the power of the tool.

## Unpacking:

When unpacking this unit, check the parts diagram and part number listing to make sure all parts are included. If any parts are missing or damaged please call your distributor.

## Maintenance/Adding Oil for Hydraulic Riveter

Your ATD-5850 riveter should be ready to use from the box, however maintenance will be needed periodically, and varies depending how often your riveter is used. When the rivet is not broken after 5 pulls of the trigger, it needs oil. Use a quality hydraulic oil such as Mobil DTE 10 or equivalent.

1. Turn off air supply
2. Use wrench to dismantle the riveter head (fig. 1).
3. Use wrench to open bottom cover of the riveter (fig. 2).
4. Remove piston from cylinder (fig. 3).
5. Clean inside of the cylinder and lubricate cover seal (fig. 4).
6. Lubricate the intake (chamber where the piston stem sits) with oil until full (fig. 5).
7. Clean piston stem and add grease on the inner wall of the cylinder and the ring.
8. Reassemble (fig.6).

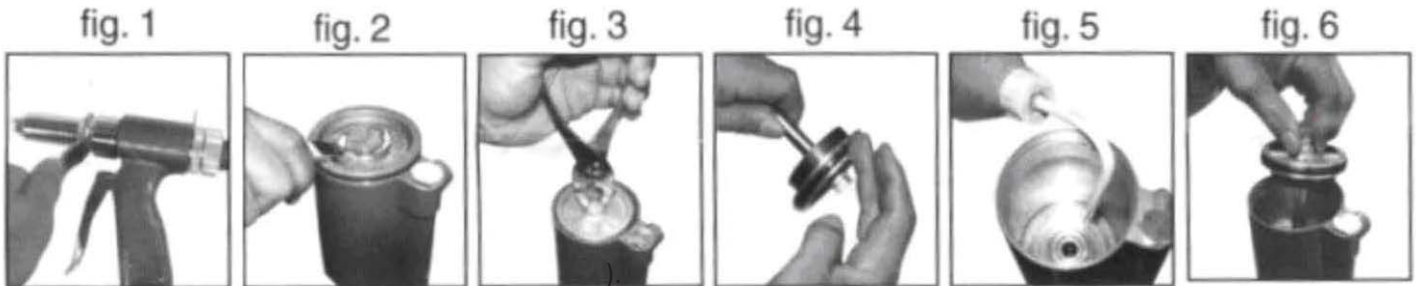

## Cleaning/Maintenance for the Head of Riveter

1. Turn off air supply. Assure all pressure is released prior to disassembly.
2. Use wrench to dismantle the riveter head (fig.1 below).
3. Use wrench to disassemble (fig. 2 below).
4. Clean all inner/assembly parts of the riveter head with a brush.
5. Reassemble the inner/assembly parts.
6. Oil the parts and reassemble riveter head completely.

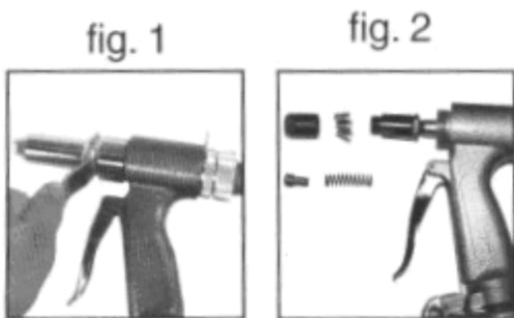



**ATD AIR**  
**ATD-5850**

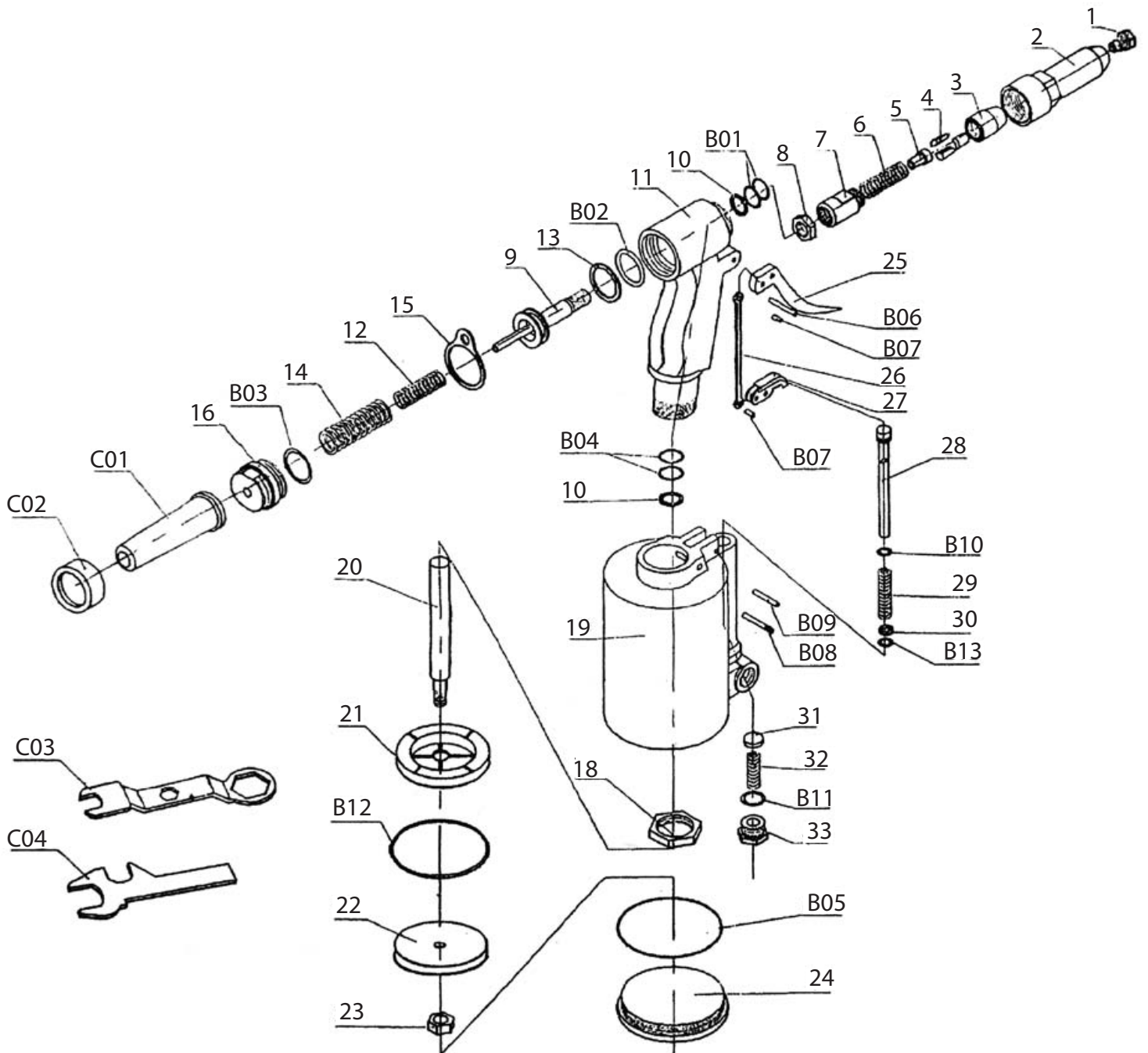



ITEM#	ORDERING PART#	PART DESCRIPTION
1	PRT5850-01	NOSEPIECE (SET OF 4)
2	PRT5850-02	OUTER CYLINDER
3	PRT5850-03	JAW CARRIER
4	PRT5850-04	JAW
5	PRT5850-05	JAW PUSHER
6	PRT5850-06	JAW PUSH SPRING
7	PRT5850-07	JAW CYLINDER
8	PRT5850-08	CASE LOCK NUT
9	PRT5850-09	PRINCIPAL AXIS
10	PRT5850-10	PLASTIC RING
11	PRT5850-11	HANDLE
12	PRT5850-12	RESTORE SPRING
13	PRT5850-13	PLASTIC RING
14	PRT5850-14	RESTORE SPRING
15	PRT5850-15	POTHOOK
16	PRT5850-16	AIRPROOF LID
18	PRT5850-18	LOCK NUT
19	PRT5850-19	AIR CYLINDER
20	PRT5850-20	POLE PISTON
21	PRT5850-21	CUSHION
22	PRT5850-22	PISTON
23	PRT5850-23	M8 NUT
24	PRT5850-24	AIR CYLINDER LID
25	PRT5850-25	TRIGGER
26	PRT5850-26	LINKER

ITEM#	ORDERING PART#	PART DESCRIPTION
27	PRT5850-27	PRESS PLANK
28	PRT5850-28	AIR VALVE
29	PRT5850-29	VALVE SPRING
30	PRT5850-30	COPPER WASHER
31	PRT5850-31	AIRPROOF PLASTIC
32	PRT5850-32	AIRPROOF SPRING
33	PRT5850-33	AIRPROOF NUT
B01	PRT5850-B01	O-RING
B02	PRT5850-B02	O-RING
B03	PRT5850-B03	O-RING
B04	PRT5850-B04	O-RING
B05	PRT5850-B05	O-RING
B06	PRT5850-B06	SPRING PIN
B07	PRT5850-B07	SPRING PIN
B08	PRT5850-B08	PIN
B09	PRT5850-B09	SPRING PIN
B10	PRT5850-B10	O-RING
B11	PRT5850-B11	O-RING
B12	PRT5850-B12	O-RING
B13	PRT5850-B13	O-RING
C01	PRT5850-C01	BOTTLE
C02	PRT5850-C02	NUT
C03	PRT5850-C03	WRENCH
C04	PRT5850-C04	WRENCH