



ATD-30338 30" Oscillating Pedestal Fan Owner's Manual



Features:

- Three-speed energy efficient motor with overheating protection
- Balanced aluminum 3-blade design provides even airflow and quiet operation
- (4) wheels on base for increased mobility
- Tubular steel stand with round base needs only limited floor space
- Automatic shut-off feature prevents overheating
- Easy height adjustment up to 75"
- Durable black powder coat finish
- 6 ft. grounded cord

Specifications:

- 1/6 Hp Motor
- Up to 5,440 CFM
- cETL listed
- Size: 32" L x 28" W x 79" H

General Safety Warnings:

 **WARNING:** The instructions and warnings contained in this manual should be read and understood before using or operating this fan. Do not allow anyone to use or operate this fan until they have read this manual and have developed a thorough understanding of how this fan works. Failure to observe any of the following instructions could result in severe personal injury to fan user and bystanders, or cause damage to the fan and property. Keep this manual for future reference.

 **Note:** The warnings and cautions discussed in this instruction manual cannot cover all possible conditions and situations that may occur. It must be understood by the operator that common sense and caution are factors which cannot be built into this product, but must be supplied by the operator.

Electrical Safety Warnings:

 **WARNING:** Read all safety warnings and instructions. Failure to follow all warnings and instructions may result in electric shock, fire and/or serious injury or death.

 **WARNING:** Before connecting a fan to a power supply, always check to ensure the power supply corresponds to the voltage on the nameplate of the fan. A power supply with a voltage greater than that specified for the fan can result in serious injury to the user, as well as damage to the fan. Using a power supply with a voltage less than the nameplate rating is harmful to the motor. If in doubt, do not plug in the fan.

 **WARNING:** Grounded fans must be plugged into an outlet properly installed and grounded in accordance with all codes and ordinances. This fan is equipped with a 3-prong plug and a 3-wire grounding system. Never remove the grounding prong or modify the plug in any way. Do not use any adapter plugs. Check with a qualified electrician if you are in doubt as to whether the outlet is properly grounded.

 **NOTE:** Double insulated fans are equipped with a polarized plug (one blade is wider than the other). This plug will fit in a polarized outlet only one way. If the plug does not fit fully in the outlet, reverse the plug. If it still doesn't fit, contact a qualified electrician to install a polarized outlet. Do not change the plug in any way.

 **WARNING:** To reduce the risk of electric shock, DO NOT use in damp conditions, on wet surfaces, or expose to rain. Do not plug in this fan or operate it with wet hands or while standing in water.

 **WARNING:** Never use the cord for carrying, pulling or unplugging the fan. Grasp plug and pull to disconnect from outlet. Keep cord away from heat, oil, sharp edges or moving parts. Replace damaged cords immediately.

 **WARNING:** Ensure the switch is in the off position before plugging the fan into the power outlet. In the event of a power failure while the fan is being used, turn the switch off to prevent surprise starting when the power is restored.

 **WARNING:** Always remove the power cord from the electric outlet when making adjustments, changing parts, cleaning or working on the fan.

 **WARNING:** Care should be taken to arrange the cord so it will not be stepped on, tripped over, or otherwise subjected to damage or stress. DO NOT run power cords under carpeting, do not cover with throw rugs or the like.

 **WARNING:** Never attempt to plug in or operate equipment with defective or damaged wires, power cord or power cord plug. Have any defective or damaged parts replaced immediately by qualified personnel.

 **WARNING:** Avoid body contact with electrically grounded surfaces. There is an increased risk of electric shock if your body is grounded.

 **WARNING:** If the work area is not equipped with a permanently installed Ground Fault Circuit Interrupter outlet (GFCI), use a plug-in GFCI between the fan and the power receptacle.

 **WARNING:** This fan is for **INDOOR** use **ONLY**.

 **WARNING:** Avoid the use of extension cords with this fan. If an extension cord **MUST** be used, be sure that it is a MINIMUM of 14 AWG and rated not less than 1875 Watts.

 **WARNING:** Never operate this fan without the protective front and rear guards in place. Do not stick anything through the guards that will come in contact with the moving blades (fingers, tools, etc.). Personal injury will result.

 **WARNING:** Never use this fan with any mister or spray attachment of any kind.

Assembly Instructions

Unpack your fan and check the contents:

- Fan Base
- Base Coupler
- Wheels
- Stand Pipe
- Adjuster
- L-Shaped Adjustment Screw
- Extension Pipe
- Motor
- Rear Guard
- Blades
- Front Guard
- Hardware Package

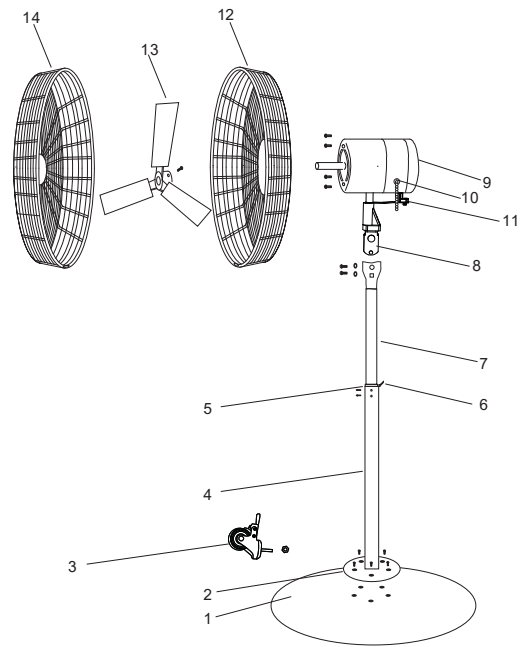

WHEEL ASSEMBLY

1. Assemble wheels to base by placing the wheel stud through the hole on the edge of the base and securing the caster with the nut provided.

STAND AND BASE ASSEMBLY

1. Place stand assembly with the spring on the base frame and align holes in the coupler with holes in the base frame.
2. Insert screws and spring washers from the screw package and tighten securely.

STAND ASSEMBLY

1. Remove the two screws from the extension pipe adjuster.
2. Insert the extension pipe into the stand pipe.
3. Align the two holes on the stand pipe with the holes on the adjuster and secure the adjuster with two the screws removed in step 2.
4. Adjust the extension pipe to desired height.
5. Tighten the L-shaped adjustment screw to set the height.

STAND/MOTOR ASSEMBLY

1. Remove the bolts, flat washers, and nuts from the extension pipe.
2. Align the upper round hole on the extension pipe assembly with the upper round hole in the motor bracket on the motor.
3. Insert the bolt and replace the flat washer and the nut removed from step 1.
4. Adjust tilt to the desired angle and insert the bolt through the lower square hole on the extension pipe assembly with the cambered slot in the motor bracket on the motor, and replace the flat washer and the nut removed from step 1.
5. Tighten the bolts and nuts.
6. Repeat step 3-5 to adjust the airflow upward or downward.

REAR GRILL AND BLADES ASSEMBLY

1. Remove the four screws, spring washers and the flat washer from the motor around the motor shaft.
2. Align the rear guard over the threaded holes in the motor. Align the rear guard so that the one small hole in the outer ring is located to your lower right when facing the fan.)
3. Secure with the flat washers, spring washers and the screws removed in step 1.
4. Remove the screw on the blades' circular slot and carefully slide the blade assembly over the shaft. Then replace and tighten the screw to fix the blades on the groove on the shaft.
5. **CAUTION:** Do not alter angle of blades, or bend them in any manner.

FRONT GRILL ASSEMBLY

1. Open the clips on the front of the guard.
2. Hang the front guard on the top rib of the rear guard by utilizing the U-shaped fixed clip on the top of the front guard.
3. Insert and secure the safety guard bolt, spring washer and nut.
4. Press the clips down around the front guard to secure.

Operating Instructions:

1. Place the fan in the upright position on a safe, flat surface where it cannot fall or be pulled by the cord.
2. Select desired direction of air flow by tilting the fan upward or downward.
3. Plug unit into electrical outlet.
4. Facing the front side of the fan, pull the right chain on the motor assembly to desired setting (high, medium and low).
5. Facing the front side of the fan, pull the left chain on the motor assembly to control the oscillation (oscillating or non-oscillating).
6. Always turn off and unplug fan after using.

NOTE: DO NOT operate the fan without the guards in place, or if it has malfunctioned or been damaged in any way.

Cleaning:

Before cleaning the fan, be sure to disconnect power cord from the power outlet. Clean the guard surface with a damp cloth. Do NOT use harsh chemicals or abrasive cleaners. DO NOT IMMERSSE THE FAN OR ANY WIRES IN WATER. Replace front guard before use. Allow fan to dry completely before use. Periodic guard cleaning with a vacuum will prevent dust build up.

Maintenance:

The motor is sealed from the factory and does not require any interior maintenance, cleaning or lubrication. The internal motor bearings are permanently lubricated and do not require any additional lubrication.

Repair:

Do not operate the fan without the guards in place. Do not use the fan if it has malfunctioned or become damaged in any way. Use only genuine parts when repairing fan. Have only an experienced technician attempt repairs.



ATD-30338

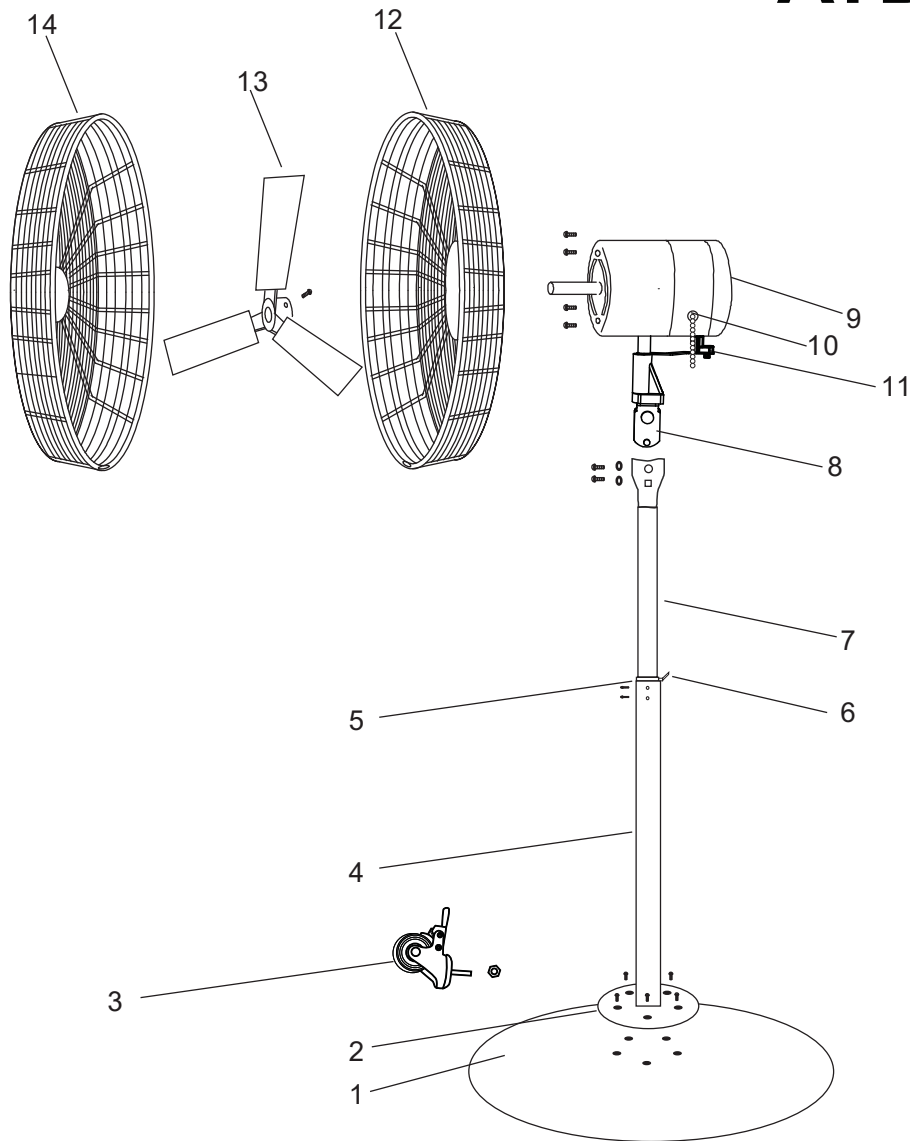

ITEM#	ORDERING PART#	PART DESCRIPTION
1	PRT30335A-01	FAN BASE
2	PRT30335A-02	COUPLER
3	PRT30335A-03	WHEELS
4	PRT30335A-04	STAND PIPE
5	PRT30335A-05	ADJUSTER
6	PRT30335A-06	L-SHAPED ADJUSTMENT SCREW
7	PRT30335A-07	EXTENSION PIPE

ITEM#	ORDERING PART#	PART DESCRIPTION
8	PRT30335A-08	MOTOR BRACKET
9	PRT30335A-09	MOTOR
10	PRT30335A-10	SWITCH
11	PRT30338-01	SWITCH FOR OSCILLATION
12	PRT30335A-11	REAR GUARD
13	PRT30330A-12	BLADES
14	PRT30335A-13	FRONT GUARD
HK	PRT30335A-HK	HARDWARE KIT



WARRANTY

1 YEAR LIMITED WARRANTY

THIS WARRANTY AND CONFIRMED RECEIPT(S) SHOULD BE RETAINED BY THE CUSTOMER AT ALL TIMES

PURCHASED FROM: _____

DATE PURCHASED: _____

INVOICE/RECEIPT NUMBER: _____

Your ATD-30338 is warranted for a period of 12 months from the original purchase date.

For a period of one (1) year from your purchase date, ATD Tools Inc. will repair or replace (at its option) without charge, your ATD product if it was purchased new and the product has failed due to a defect in material or workmanship which you experienced during normal use of the product. This limited warranty is your exclusive remedy.

To access the benefits of this warranty, contact your supplier, or point of sale directly. You may be advised to return the product under warranty, freight prepaid, to your supplier for warranty determination.

If this ATD product is altered, abused, misused, modified, or undergoes service by an unauthorized technician, your warranty will be void. We are not responsible for damage to ornamental designs you place on this ATD product and such ornamentation should not cover any warnings or instructions or they may void the warranty. This warranty does not cover scratches, superficial dents, and other abrasions to the paint finish that occur under normal use. It also does not cover normal wear items such as but not limited to brushes, batteries, drill bits, drill chucks, pads or blades.

Subject to the law in your state:

- (1) Your sole and exclusive remedy is repair or replacement of the defective product as described above.
- (2) ATD is not liable for any incidental damages, including but not limited to, lost profits and unforeseeable consequences.
- (3) The repair and replacement of this product under the express limited warranty described above is your exclusive remedy and is provided in lieu of all other warranties, express or implied. All other warranties, including implied warranties and warranties of merchantability or fitness for a particular purpose are disclaimed and, if disclaimer is prohibited, these warranties are limited to one year from your date of purchase of this product.

Some states' laws do not allow limited durations on certain implied warranties and some states' laws do not allow limitations on incidental or consequential damages. You should consult the law in your state to determine how your rights may vary.

[Affix receipt or invoice here for safe keeping]