



ATD-10506 RANDOM ORBITAL POLISHER OWNER'S MANUAL



* Shown with both handles included



Features:

- Random orbit polishing action for swirl-free finish
- Includes multi-position side handle and D-handle for comfort
- Variable speed settings allows the correct amount of polishing power for each application
- Soft start feature provides improved speed control
- Rubber grip provides added comfort and reduces vibration
- 6" hook and loop backing pad makes changing pads fast and easy
- Accepts 5/16"x24 spindle thread accessories
- 6A, 120V AC, 60 HZ
- No load speed: 2500-6500 OPM



WARNING





WARNING: This product may contain chemicals, including lead, known to the State of California to cause cancer, birth defects or other reproductive harm. *Wash hands after handling.*

Made in China to ATD Tools, Inc. Specifications
Visit us at www.atdtools.com

General Safety Warnings:

 **WARNING:** The instructions and warnings contained in this manual should be read and understood before using or operating this tool. Do not allow anyone to use or operate this tool until they have read this manual and have developed a thorough understanding of how this tool works. Failure to observe any of the following instructions could result in severe personal injury to tool user and bystanders, or cause damage to the tool and property. Keep this manual for future reference.

 **Note:** The warnings and cautions discussed in this instruction manual cannot cover all possible conditions and situations that may occur. It must be understood by the operator that common sense and caution are factors which cannot be built into this product, but must be supplied by the operator.

 **WARNING:** Use safety equipment. User and bystanders should use safety goggles or safety glasses with side shields which comply with current national standards, or when needed, a face shield. Use an ANSI approved dust mask or respirator when working around metal, wood, and chemical dusts and mists. This applies to all persons in the work area. Also use non-skid safety shoes, hardhat, gloves, dust collection systems, and hearing protection when appropriate.

 **WARNING:** Keep bystanders and children out of the work area while operating this tool.

 **WARNING:** Always keep your work area clean, uncluttered, and well lit. Cluttered or dark areas invite accidents and injuries. DO NOT work on floor surfaces that are slippery.

 **WARNING:** Do not operate this tool if you are tired or under the influence of alcohol, drugs, or medications that could affect your ability to use the tool properly.

 **WARNING:** Dress properly. Do not wear loose clothing or jewelry as they can be caught in moving parts. Wear restrictive hair covering to contain long hair.

 **WARNING:** Do not reach over or across running machines. Keep proper footing and balance at all times. Non-skid footwear is recommended when working.

Electrical Safety Warnings:

 **WARNING:** Read all safety warnings and instructions. Failure to follow all warnings and instructions may result in electric shock, fire and/or serious injury or death.

 **WARNING:** Before connecting a tool to a power supply, always check to ensure the power supply corresponds to the voltage on the nameplate of the tool. A power supply with a voltage greater than that specified for the tool can result in serious injury to the user, as well as damage to the tool. Using a power supply with a voltage less than the nameplate rating is harmful to the motor. If in doubt, do not plug in the tool.

 **NOTE:** Double insulated tools are equipped with a polarized plug (one blade is wider than the other). This plug will fit in a polarized outlet only one way. If the plug does not fit fully in the outlet, reverse the plug. If it still doesn't fit, contact a qualified electrician to install a polarized outlet. Do not change the plug in any way.

 **WARNING:** To reduce the risk of electric shock, DO NOT use in damp conditions, on wet surfaces, or expose to rain. Do not plug in this tool or operate it with wet hands or while standing in water.

 **WARNING:** Never use the cord for carrying, pulling or unplugging the power tool. Grasp plug and pull to disconnect from outlet. Keep cord away from heat, oil, sharp edges or moving parts. Replace damaged cords immediately.

 **WARNING:** Do not carry the power tool with your finger on the switch. Ensure the switch is in the off position before plugging the tool into the power outlet. In the event of a power failure while a tool is being used, turn the switch off to prevent surprise starting when the power is restored.

 **WARNING:** Always remove the power cord from the electric outlet when making adjustments, changing parts, cleaning or working on the tool.

 **WARNING:** Care should be taken to arrange the cord so it will not be stepped on, tripped over, or otherwise subjected to damage or stress.

 **WARNING:** Never attempt to plug in or operate equipment with defective or damaged wires, power cord or power cord plug. Have any defective or damaged parts replaced immediately by qualified personnel.

 **WARNING:** Avoid body contact with electrically grounded surfaces. There is an increased risk of electric shock if your body is grounded.

 **WARNING:** If the work area is not equipped with a permanently installed Ground Fault Circuit Interrupter outlet (GFCI), use a plug-in GFCI between the power tool or extension cord and the power receptacle.

 **WARNING:** If an extension cord is necessary, use only 'Listed' extension cords. If used outdoors, they must be marked "For Outdoor Use".

 **WARNING:** Use of improper size or gauge of extension cord may cause unsafe or inefficient operation of your tool, or cause damage to your tool. Be sure your extension cord is rated to allow sufficient current flow to the motor. If in doubt, always use a larger gauge cord. Be sure to check the voltage requirements of the tool to your incoming power source.

 **NOTE:** The table below shows the correct size to use according to cord length and the amperage draw of the tool (specified on the nameplate). When in doubt, use the next heavier gauge. The smaller the gauge number, the heavier the cord. (AWG = American Wire Gauge).

Minimum Gauge for Extension Cords (AWG)
(when using 120 volts only)

Ampere Rating		Total Length of Cord in Feet (meters)			
More Than	Not More Than	25' (7.6m)	50' (15m)	100' (30.4m)	150' (45.7m)
0	6	18	16	16	14
6	10	18	16	14	12
10	12	16	16	14	12
12	16	14	12	Not Recommended	

Power Tool Use and Care:

 **NOTE:** The term "power tool" in the warnings refers to your electrically operated (corded) power tool or battery operated (cordless) power tool.

 **WARNING:** Beware of all power lines, electrical circuits, water pipes and other mechanical hazards in your work area, particularly those below the work surface hidden from the operators view. Unintentional contact with these hazards may cause personal injury or property damage.

 **WARNING:** Do not force the power tool. Use the correct power tool for your application. *The correct power tool will do the job better and safer at the rate for which it was designed.*

 **WARNING:** Do not use the power tool if the switch loses its function. *Any power tool that cannot be controlled with the switch is dangerous and must be repaired.*

 **WARNING:** Do not operate power tools in explosive atmospheres, such as in the presence of flammable liquids, gases or dust. *Power tools create sparks which may ignite the dust or fumes.*

 **WARNING:** Make sure that stored or idle power tools are out of the reach of children and do not allow persons unfamiliar with the power tool or these instructions to operate the power tool. *Power tools are dangerous in the hands of untrained users.*

 **WARNING:** Maintain power tools. Check for misalignment or binding of moving parts, breakage of parts and any other conditions that may affect the power tools operation. If damaged, have the power tool repaired before using it. *Many accidents are caused by poorly maintained power tools.*

 **WARNING:** If devices are provided for the connection of dust extraction and collection facilities, ensure that these are connected and properly used.

 **WARNING:** Remove adjusting keys or wrenches before turning the tool on. *A wrench or a key that is left attached to a rotating part of the tool may result in personal injury.*

 **WARNING:** Have your power tool serviced by a qualified repair person using only identical replacement parts. This will ensure that the power tool is safe.

REPETITIVE MOTION / VIBRATION HAZARDS:

 **WARNING:** Avoid prolonged exposure to vibration. Vibration, repetitive motions, or uncomfortable positions over extended periods of time may be harmful to your hands and arms. Do not ignore symptoms or persistent or recurring discomfort, pain, throbbing, aching, tingling, numbness, burning sensation, or stiffness. Discontinue use of the tool and seek medical advice before resuming use.

 **WARNING:** Adopt a comfortable posture while maintaining secure footing and avoiding awkward or off balance postures. Changing posture during extended tasks can help avoid discomfort and fatigue.

Operating Instructions



Read the ENTIRE IMPORTANT SAFETY INFORMATION section at the beginning of this manual including all text under subheadings therein before set up or use of this power tool.



WARNING:

TO PREVENT SERIOUS INJURY FROM ACCIDENTAL OPERATION:

Make sure that the Power Switch is in the off-position and unplug the tool from its electrical outlet before performing any procedure in this section.

Note: For additional information regarding the parts listed in the following pages, refer to the Assembly Diagram near the end of this manual.

ASSEMBLY

Installing the Side Handle



WARNING:

TO PREVENT SERIOUS INJURY:

Do not operate this tool with one hand only or without one of the two handles properly installed.

1. The Side Handle may be installed in one of two positions, on either side of the Gear Housing.
2. Screw the threaded end of the Side Handle into the selected position. Tighten securely before beginning work.

Functions

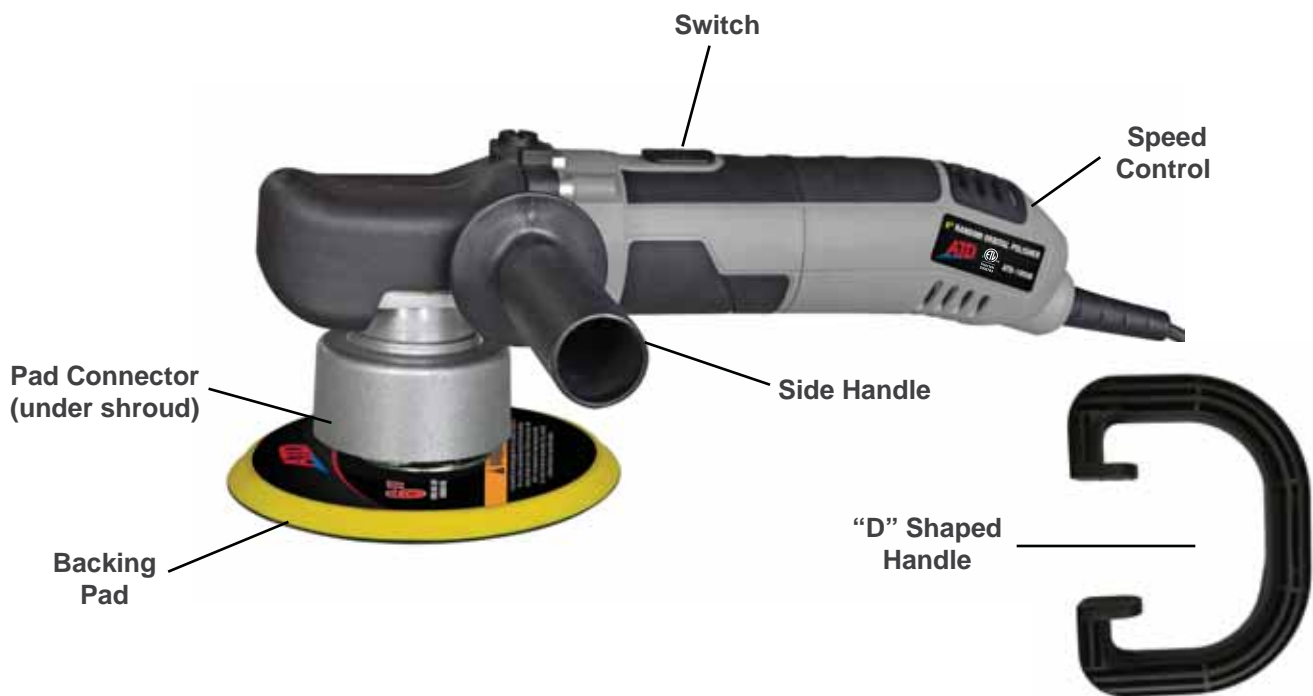

ASSEMBLY

Installing the “D” Shaped Handle

WARNING:

TO PREVENT SERIOUS INJURY:

Do not operate this tool with one hand only or without the one of the two handles properly installed.

1. The “D” Shaped Handle may be installed in place of the Side Handle.
2. Use the two hex socket cap screws provided to screw the “D” Shaped Handle into selected position. Once screw on each side of the gear housing. Tighten securely before beginning work.

Operating Instructions



Read the ENTIRE IMPORTANT SAFETY INFORMATION section at the beginning of this manual including all text under subheadings therein before set up or use of this product.

TOOL SET UP

WARNING:

TO PREVENT SERIOUS INJURY FROM ACCIDENTAL OPERATION:

Make sure that the power switch is in the off-position and unplug the tool from its electrical outlet before performing any procedure in this section.

Installing a Threaded Accessory

1. The accessory MUST be:
 - Rated to at least 6,500 OPM.
 - No larger than 6” (150mm) in diameter.
 - Fitted with a threaded opening of 5/16” - 24 UNF.
 - Undamaged.
 - A sanding disc, polishing bonnet or foam pad (sold separately) and backing pad.
2. Use the included wrench to prevent the spindle from turning.
3. Thread disc accessory firmly onto the spindle.
4. Remove the wrench before use.

WORKPIECE AND WORK AREA SET UP

1. Designate a work area that is clean and well-lit. The work area must not allow access by children or pets to prevent distraction and injury.
2. Route the power cord along a safe route to reach the work area without creating a tripping hazard or exposing the power cord to possible damage. The power cord must reach the work area with enough extra length to allow free movement while working.
3. Secure loose workpieces using a vise or clamps (not included) to prevent movement while working.
4. There must not be hazardous objects, such as utility lines or foreign objects, nearby that will present a hazard while working.
5. You must use personal safety equipment including, but not limited to, ANSI-approved eye and hearing protection, as well as heavy-duty work gloves.

Polishing Instructions

WARNING:

TO PREVENT SERIOUS INJURY: Grip the tool firmly in both hands.

1. Wash the work surface thoroughly, and make sure it is free of dust, dirt, oil, grease, etc.
2. Place a clean foam pad (sold separately) securely onto the backing pad.
2. Apply about two tablespoons of wax (not included) evenly on the clean foam pad.

NOTICE: Do not apply the wax directly to the surface of the vehicle. The amount of wax needed will vary according to the size of the vehicle being waxed.

NOTICE: Only use slower speeds for polishing. Otherwise, damage may occur to the paint being polished. ATD Tools, Inc. is not responsible for damage to the vehicle's finish due to improper use of this tool.

3. Make sure that the switch is in the off position, then plug in the tool.

WARNING! To prevent electric shock, keep electrical connections off ground.

CAUTION! Start and stop the tool only while it is held firmly against the surface of the vehicle. Failure to do so may result in the foam pad or polishing bonnet being thrown from the polishing pad.

4. To start, position the unit on the area to be polished, grip the tool firmly with both hands and press the Trigger. Release the trigger to stop.
5. Keep pressure off of the tool when operating. The foam pad should **LIGHTLY** contact the polishing surface.

NOTICE: To prevent damage to the foam pad, polishing bonnet, and vehicle finish: Only apply the pad/bonnet flat against the surface, see below.

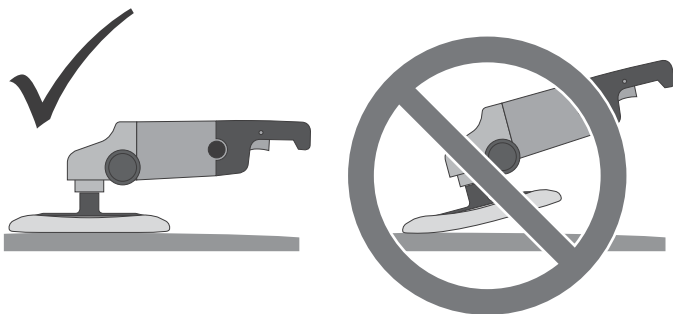

Figure A: Polishing Angle

6. Begin using the tool to apply wax to the vehicle. Apply the wax to all flat surfaces with broad, sweeping strokes in a crisscross pattern. Apply the wax evenly over the surface of the vehicle.

7. Add additional wax to the polishing pad as needed. To add additional wax:
 - a. Stop the tool and allow the tool to come to a complete stop.
 - b. Add a small amount of wax evenly over the pad surface.
 - c. Avoid using too much wax. For additional applications of wax to foam pad, reduce the amount of wax. The foam pad will not absorb as much wax in subsequent applications.
 - d. Resume operation.

Note: The most common error when waxing/polishing a vehicle is applying too much wax. If the foam pad becomes saturated with wax, applying wax will be more difficult and will take longer. Applying too much wax may also reduce the life of the foam pad. If the foam pad continually comes off the backing pad during use, too much wax may have been applied.

8. After the wax has been applied to the vehicle's surface, turn off the tool. Unplug the power cord from the extension cord.
9. Remove the foam pad from the backing pad and with your hand and the foam pad, apply wax to any hard to reach areas of the vehicle such as around lights, door handles, under bumpers, etc.
10. Allow sufficient time for the wax to dry.
11. Place a clean polishing bonnet (sold separately) securely onto the backing pad.

CAUTION! Tightly pull the string to secure the polishing bonnet. Secure the string and keep it out of the way by tying several knots.

CAUTION! Start and stop the tool only while it is held firmly against the surface of the vehicle. Failure to do so may result in the bonnet being thrown from the backing pad.

12. Start the tool and begin buffing off the dried wax.
13. When as much wax as possible has been removed with the tool, turn off the tool. Unplug the tool.
14. **WARNING! Allow the tool to come to a complete stop before setting it down.**
15. Remove the polishing bonnet from backing pad. Using the polishing bonnet, remove the wax from all hard to reach areas of the vehicle.
16. Clean, then store the tool indoors out of children's reach.

Sanding Instructions

WARNING:

TO PREVENT SERIOUS INJURY: Grip the tool firmly in both hands.

1. Wipe the work surface clean of all dirt and debris, especially that of previous coarser sanding sessions, which will scratch the surface of a finer grit sanding session.
2. Attach the desired grit sanding disk (sold separately) onto the backing pad.
3. Make sure that the switch is in the off position, then plug in the tool.
4. To start, grip the tool firmly with both hands and press the trigger. Release the trigger to stop.
5. Wait until the tool has reached full speed, then gently contact the surface.
6. Keep heavy pressure off of the tool when operating. Allow the tool to do the work.
7. Move the tool in a uniform pattern up and down or side to side while sanding to ensure even sanding.
8. Periodically, stop the tool and check for disc wear. Replace worn sanding discs as needed.
9. **TO PREVENT ACCIDENTS, AFTER USE:**
Turn off the tool.
WARNING! Allow the tool to come to a complete stop before setting it down.
Unplug the tool. Clean, then store the tool indoors out of children's reach.

Maintenance and Servicing



Procedures not specifically explained in this manual must be performed only by a qualified technician.

WARNING:

TO PREVENT SERIOUS INJURY FROM ACCIDENTAL OPERATION:

Make sure that the power switch is in the off-position and unplug the tool from its electrical outlet before performing any procedure in this section.

TO PREVENT SERIOUS INJURY FROM TOOL FAILURE:

Do not use damaged equipment. If abnormal noise or vibration occurs, have the problem corrected before further use.

CLEANING, MAINTENANCE, AND LUBRICATION

1. **BEFORE EACH USE**, inspect the general condition of the tool. Check for:
 - loose hardware,
 - misalignment or binding of moving parts,
 - damaged cord/electrical wiring,
 - cracked or broken parts, and
 - any other condition that may affect its safe operation.
2. **AFTER USE**, wipe external surfaces of the tool with clean cloth.
3. Periodically, wear ANSI-approved safety goggles and NIOSH-approved breathing protection and blow dust and grit out of the motor vents using dry compressed air.
4. **WARNING! If the supply cord of this power tool is damaged, it must be replaced only by a qualified service technician.**

Troubleshooting

Problem	Possible Causes	Likely Solutions
Tool will not start.	<ol style="list-style-type: none"> 1. Cord not connected. 2. No power at outlet. 3. Tool's thermal reset breaker tripped (if equipped). 4. Internal damage or wear. (Carbon brushes or switch, for example.) 	<ol style="list-style-type: none"> 1. Check that cord is plugged in. 2. Check power at outlet. If outlet is unpowered, turn off tool and check circuit breaker. If breaker is tripped, make sure circuit is right capacity for tool and circuit has no other loads. 3. Turn off tool and allow to cool. Press reset button on tool. 4. Have technician service tool.
Tool operates slowly.	<ol style="list-style-type: none"> 1. Excess pressure applied to workpiece. 2. Power being reduced by long or small diameter extension cord. 	<ol style="list-style-type: none"> 1. Decrease pressure, allow tool to do the work. 2. Eliminate use of extension cord. If an extension cord is needed, use one with the proper diameter for its length and load. See <i>Extension Cords</i> in <i>GROUNDING</i> section.
Performance decreases over time.	Carbon brushes worn or damaged.	Have qualified technician replace brushes.
Excessive noise or rattling.	Internal damage or wear. (Carbon brushes or bearings, for example.)	Have technician service tool.
Overheating.	<ol style="list-style-type: none"> 1. Forcing tool to work too fast. 2. Blocked motor housing vents. 3. Motor being strained by long or small diameter extension cord. 	<ol style="list-style-type: none"> 1. Allow tool to work at its own rate. 2. Wear ANSI-approved safety goggles and NIOSH-approved dust mask/respirator while blowing dust out of motor using compressed air. 3. Eliminate use of extension cord. If an extension cord is needed, use one with the proper diameter for its length and load. See <i>Extension Cords</i> in <i>GROUNDING</i> section.
Tool does not sand effectively.	<ol style="list-style-type: none"> 1. Accessory loose. 2. Accessory damaged, worn or wrong type for the material. 	<ol style="list-style-type: none"> 1. Confirm accessory arbor is correct and tight. 2. Check condition and type of disc accessory. Use only proper type of disc accessory in good condition.



Follow all safety precautions whenever diagnosing or servicing the tool. Disconnect power supply before service.



ATD-10506

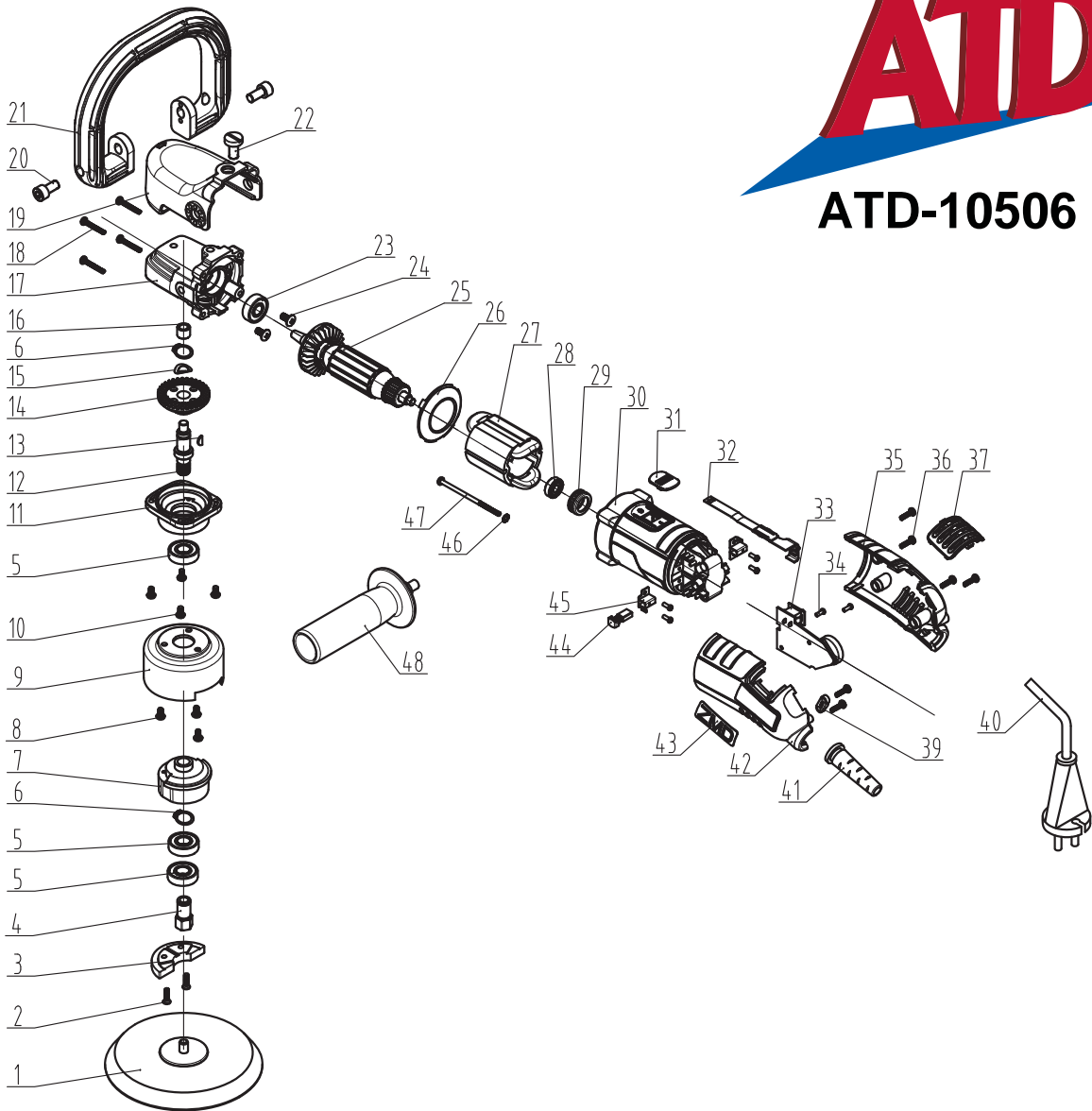

ITEM#	ORDERING PART#	PART DESCRIPTION
1	PRT10506-01	BACKING PAD
2	PRT10506-02	SCREW M4X12
3	PRT10506-03	COUNTER WEIGHT
4	PRT10506-04	SPINDLE 01
5	PRT10506-05	BEARING 6001
6	PRT10506-06	RING 12
7	PRT10506-07	ECCENTRIC WHEEL
8	PRT10506-08	SCREW M4X10
9	PRT10506-09	ECCENTRIC PLATE
10	PRT10506-10	SCREW M4X14
11	PRT10506-11	GEAR BOX CAP
12	PRT10506-12	SPINDLE 02
13	PRT10506-13	WOODRUFF KEY 3X3.7X10
14	PRT10506-14	BIG GEAR
15	PRT10506-15	GEAR RETAINING RING
16	PRT10506-16	BEARING 12X8X10
17	PRT10506-17	GEAR BOX
18	PRT10506-18	SCREW ST4.2X22
19	PRT10506-19	GEAR BOX COVER
20	PRT10506-20	SCREW M8X15
21	PRT10506-21	D-HANDLE
22	PRT10506-22	SCREW M8X12
23	PRT10506-23	BEARING 6000
24	PRT10506-24	SCREW M5X10

ITEM#	ORDERING PART#	PART DESCRIPTION
25	PRT10506-25	ROTOR
26	PRT10506-26	FAN SHROUD
27	PRT10506-27	STATOR
28	PRT10506-28	BEARING 607
29	PRT10506-29	BEARING BUSHING 607
30	PRT10506-30	HOUSING
31	PRT10506-31	PUSH BUTTON
32	PRT10506-32	TIE ROD
33	PRT10506-33	PC BOARD AND SWITCH
34	PRT10506-34	SCREW ST2.9X10
35	PRT10506-35	RIGHT REAR HOUSING
36	PRT10506-36	SCREW ST4.2X14
37	PRT10506-37	AIR INTAKE FASTENER
39	PRT10506-39	CORD CLAMP
40	PRT10506-40	POWER CORD
41	PRT10506-41	CORD SLEEVE
42	PRT10506-42	LEFT REAR HOUSING
43	PRT10506-43	LABEL
44	PRT10506-44	CARBON BRUSH
45	PRT10506-45	BRUSH HOLDER
46	PRT10506-46	CARRIER RING
47	PRT10506-47	SCREW ST4.2X60
48	PRT10506-48	SIDE HANDLE



WARRANTY

1 YEAR LIMITED WARRANTY

THIS WARRANTY AND CONFIRMED RECEIPT(S) SHOULD BE RETAINED BY THE CUSTOMER AT ALL TIMES

PURCHASED FROM: _____

DATE PURCHASED: _____

INVOICE/RECEIPT NUMBER: _____

Your ATD-10506 is warranted for a period of 12 months from the original purchase date.

For a period of one (1) year from your purchase date, ATD Tools Inc. will repair or replace (at its option) without charge, your ATD product if it was purchased new and the product has failed due to a defect in material or workmanship which you experienced during normal use of the product. This limited warranty is your exclusive remedy.

To access the benefits of this warranty, contact your supplier, or point of sale directly. You may be advised to return the product under warranty, freight prepaid, to your supplier for warranty determination.

If this ATD product is altered, abused, misused, modified, or undergoes service by an unauthorized technician, your warranty will be void. We are not responsible for damage to ornamental designs you place on this ATD product and such ornamentation should not cover any warnings or instructions or they may void the warranty. This warranty does not cover scratches, superficial dents, and other abrasions to the paint finish that occur under normal use. It also does not cover normal wear items such as but not limited to brushes, batteries, drill bits, drill chucks, pads or blades.

Subject to the law in your state:

- (1) Your sole and exclusive remedy is repair or replacement of the defective product as described above.
- (2) ATD is not liable for any incidental damages, including but not limited to, lost profits and unforeseeable consequences.
- (3) The repair and replacement of this product under the express limited warranty described above is your exclusive remedy and is provided in lieu of all other warranties, express or implied. All other warranties, including implied warranties and warranties of merchantability or fitness for a particular purpose are disclaimed and, if disclaimer is prohibited, these warranties are limited to one year from your date of purchase of this product.

Some states' laws do not allow limited durations on certain implied warranties and some states' laws do not allow limitations on incidental or consequential damages. You should consult the law in your state to determine how your rights may vary.

[Affix receipt or invoice here for safe keeping]