

SABER® II

ATD-80352 SABER II 7W CORDLESS UNDERHOOD LIGHT USER'S MANUAL



FEATURES:

- 14 Super Bright SMD LEDs
- 7.4V 4000mAh Li-Ion battery pack
- Up to 3-4 hours of continuous use
- Automatic shut off and over charge protection, prolongs battery life
- ABS handle with double injection, impact protection and ergonomic design provides comfortable use
- Aluminum alloy hook with PVC cover for protection, soft coated padded hooks help prevent scratching of the vehicles surface
- The bar extends from 47" to 70" and easily attaches to most SUV's and trucks
- 360 degree ratcheting hooks provide safe and firm attachment
- UL listed charger

California Prop 65 WARNING:

This product contains chemicals including lead, known to the State of California to cause cancer, birth defects, or other reproductive harm. **Wash hands after handling.**

General Safety Warnings:

 **WARNING:** The instructions and warnings contained in this manual should be read and understood before using or operating this tool. Do not allow anyone to use or operate this tool until they have read this manual and have developed a thorough understanding of how this tool works. Failure to observe any of the following instructions could result in severe personal injury to tool user and bystanders, or cause damage to the tool and property. Keep this manual for future reference.

 **Note:** The warnings and cautions discussed in this instruction manual cannot cover all possible conditions and situations that may occur. It must be understood by the operator that common sense and caution are factors which cannot be built into this product, but must be supplied by the operator.

 **WARNING:** Use safety equipment. Users and bystanders should use safety goggles or safety glasses with side shields which comply with current national standards, or when needed, a face shield. Use an ANSI approved dust mask or respirator when working around metal, wood, and chemical dusts and mists. This applies to all persons in the work area. Also use non-skid safety shoes, hardhat, gloves, dust collection systems, and hearing protection when appropriate.

 **WARNING:** Keep bystanders and children out of the work area while operating this tool.

 **WARNING:** Always keep your work area clean, uncluttered, and well lit. Cluttered or dark areas invite accidents and injuries. DO NOT work on floor surfaces that are slippery.

 **WARNING:** Do not operate this tool if you are tired or under the influence of alcohol, drugs, or medications that could affect your ability to use the tool properly.

 **WARNING:** Dress properly. Do not wear loose clothing or jewelry as they can be caught in moving parts. Wear restrictive hair covering to contain long hair.

 **WARNING:** Do not reach over or across running machines. Keep proper footing and balance at all times. Non-skid footwear is recommended when working.

Electrical Safety Warnings:

 **WARNING:** Read all safety warnings and instructions. Failure to follow all warnings and instructions may result in electric shock, fire and/or serious injury or death.

 **WARNING:** To reduce the risk of electric shock, DO NOT use in damp conditions, on wet surfaces, or expose to rain. Do not plug in this tool or operate it with wet hands or while standing in water.

 **WARNING:** Always remove the charging cord from the electric outlet when making adjustments, changing parts, cleaning or working on the tool.

 **WARNING:** Care should be taken to arrange the charging cord so it will not be stepped on, tripped over, or otherwise subjected to damage or stress.

 **WARNING:** Never attempt to plug in or operate equipment with defective or damaged wires, power cord or power cord plug. Have any defective or damaged parts replaced immediately by qualified personnel.

 **WARNING:** Avoid body contact with electrically grounded surfaces. There is an increased risk of electric shock if your body is grounded.

 **WARNING:** If the work area is not equipped with a permanently installed Ground Fault Circuit Interrupter outlet (GFCI), use a plug-in GFCI between the power tool or extension cord and the power receptacle.

ATD-80352 Specific Safety Instructions:

 **WARNING:** Read all instructions before using

 **WARNING:** For indoor use only – do not use in or around, tubs, showers, sinks, pools, hot tubs, or in a wet environment

 **WARNING:** Use only the recommended voltage and frequency requirements

 **WARNING:** Do not move or turn off light by pulling the charging cord

 **WARNING:** Do not use if the cords or clear tube are damaged

 **WARNING:** Keep out of reach of children

 **WARNING:** Do not operate light with wet hands.

 **WARNING:** Keep lamp away from hot objects.

Operating Instructions:

- To use, plug the unit into any 110-120 VAC power source, such as a wall receptacle.
- Let the unit fully charge until the green indicator on the charger turns on before use.
- Charge this light every month if not in constant use, and after each use if it is used often to insure longevity.
- Press the switch at the handle to turn unit on, press the switch again to turn it off.



- The hooks can be adjusted by simply pulling out on them and affixing to whatever surface you like, such as a car hood. (Up to 70" wide)



- Once your light is in place, it can be rotated to the desired position by simply twisting the light. You will hear ratcheting "clicks" as you rotate it.

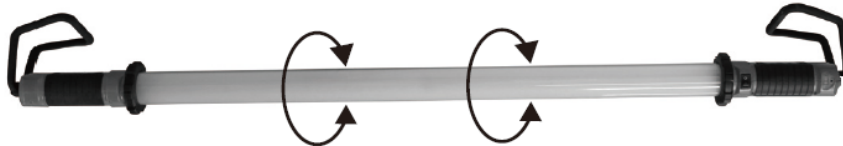

SABER® II

ATD-80352

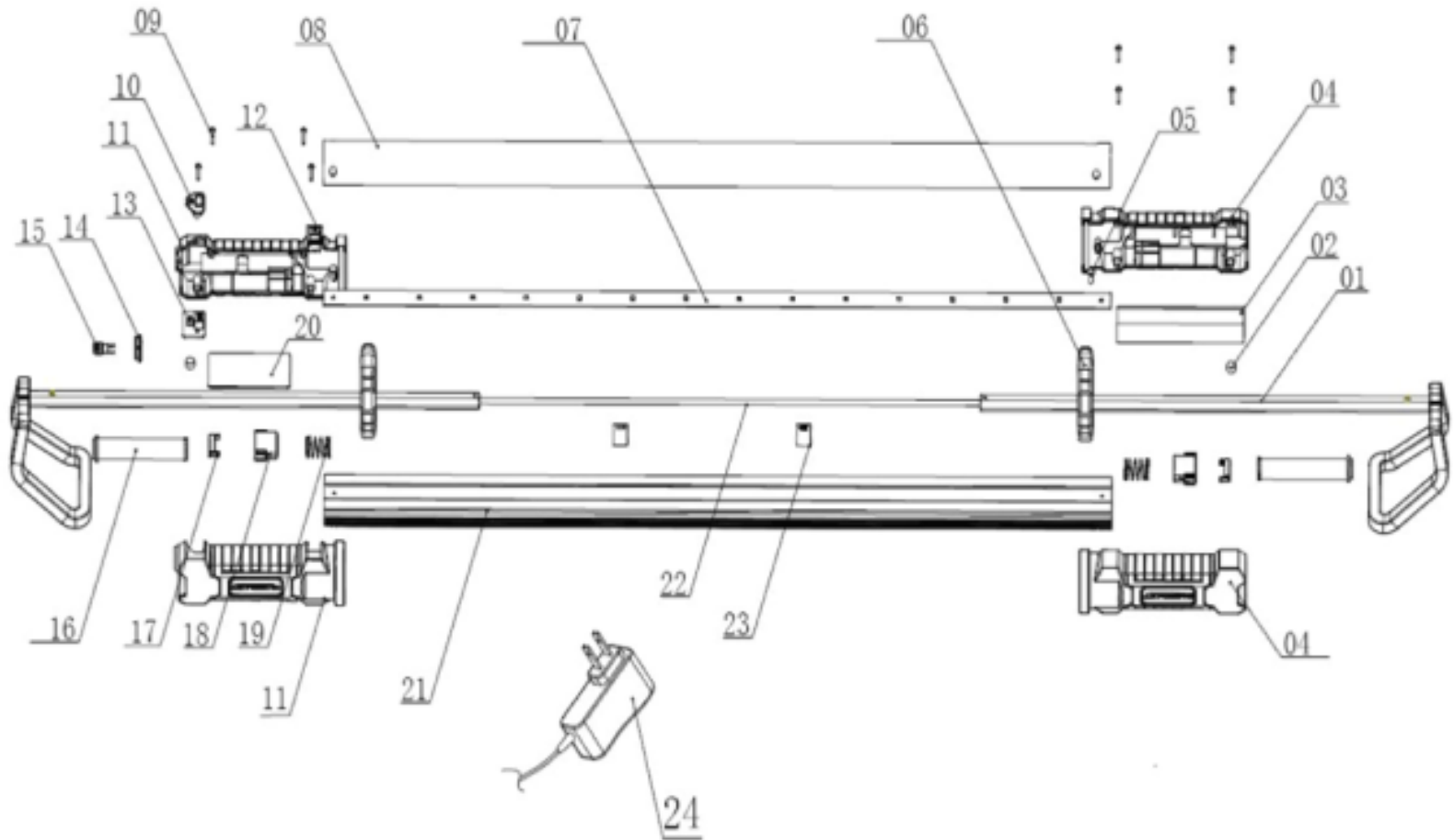

ITEM#	ORDERING PART#	PART DESCRIPTION
1	PRT80351-01	PULL ROD
2	PRT80351-02	SCREW M5X9
3	PRT80352-03	LH-ION BATTERY
4	PRT80351-03	LEFT HANDLE SET
5	PRT80351-04	SCREW M3X5
6	PRT80351-05	PROTECTING COVER
7	PRT80352-07	LED PCB
8	PRT80351-07	CLEAR TUBE LOWER
9	PRT80351-08	SCREW 2.9 X16
10	PRT80351-09	BATTERY INDICATE COVER
11	PRT80351-10	RIGHT HANDLE SET
12	PRT80351-11	ON/OFF SWITCH

ITEM#	ORDERING PART#	PART DESCRIPTION
13	PRT80352-13	BATTERY CAPACITY INDICATE
14	PRT80352-14	DC OUTLET
15	PRT80352-15	CHARGING WIRE
16	PRT80351-14	SWIVEL SHAFT
17	PRT80351-15	POSITION BLOCK
18	PRT80351-16	LAMP HOLDER
19	PRT80351-17	PRESSURE SPRING
20	PRT80352-20	PCBA
21	PRT80351-19	ALUMINUM TUBE UPPER
22	PRT80351-20	ELASTIC BAND
23	PRT80351-21	BLOCK
24	PRT80352-24	CHARGER

Visit us at www.atdtools.com

Copyright (C) 2013 ATD Tools, Inc. All rights reserved.