



ATD-6561 18" MASKING MACHINE OWNER'S MANUAL

ASSEMBLY INSTRUCTIONS

You will need an assortment of small hand tools to complete assembly of this Masking Machine.

1. Find a suitable assembly area, and arrange the parts for the masking station where they can easily be worked with.
2. Insert one front frame (07) into one rear frame (05) as shown in **Figure 1**. Insert the swaged end of the front frame into the curved portion of the rear frame near the handle. Be sure the lock buttons on the front frames fit into the holes in the rear frames.
3. Assemble the large bottom tray (03) between the two frame assemblies. Attach using two screws, four washers and two nuts per side.
4. Insert the axle (01) through the bottom holes in the rear frames, as shown in **Figure 2**. Secure with snap rings.
5. Assemble the wheels. Slide one wheel (02) and one axle nut per side as in **Figure 3**. Tighten the nuts.

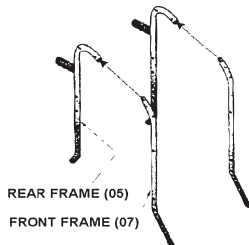

Figure 1. Frame Assembly

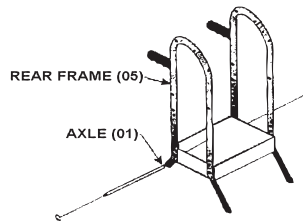

Figure 2. Large Tray and Axle Assembly

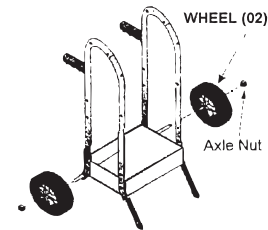

Figure 3. Wheel Installation

6. Remove the wing bolts and washers from each spring bar assembly. Slide 2 sets of paper roll components onto each spring bar.
7. Place a spring bar assembly between the upper-most holes in the frame assemblies. Insert the wing bolts and washers through the holes in the frame assemblies and into the spring bar assembly.
8. Repeat steps 6 and 7, placing the second spring bar assembly between the large holes in the rear frame above the large bottom tray. See **Figure 4**.
9. Insert one long bolt and large washer through the rear frame (as viewed from behind the wheels), using the hole located behind the hand grip. Place a large washer and nut onto the threads and tighten against the rear frame as shown in **Figure 5**.

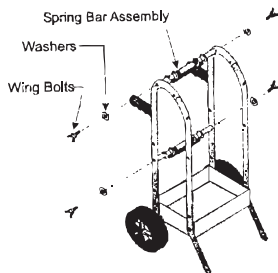

Figure 4. Spring Bar Installation

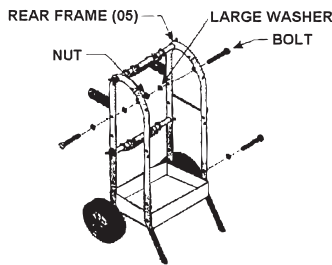

Figure 5. Tape Roll Holder Bolt Assembly

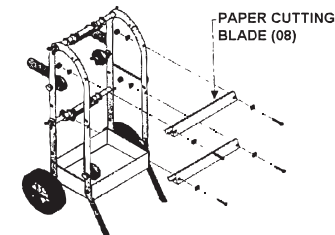

Figure 6. Cutting Blade Installation

10. Repeat step 9 using the hole below the hand grip in the right rear frame.
11. Repeat step 9 using the holes located on the front frames just above the large bottom tray.
12. Select one of the bolts you have just installed, and thread a wing nut and washer half way onto the bolt. Thread the wing nut on so that the flat side of the wing nut faces to the inside of the frame assembly.
13. Insert the metal bushings into the center of the tape roll holders.
14. Place one tape roll holder with the metal bushing installed onto one of the bolts. Face the tape roll holder so the flanges are nearest to the frame. Thread on a washer and wing nut to the bolt. Tighten against the tape roll holder.
15. Repeat steps 12-14 to install the remaining three tape roll holders.
16. Install both cutting blades (08) onto the front frames as shown in **Figure 6**. Mount upper blade with the cutting edge down, and lower blade with cutting edge up. Assemble using two screws, four washers, and two nuts per paper cutting blade.
17. Attach the small side tray to the right side of the assembly using two bolts, nuts and washers.
18. Attach the towel holder to the left side of the assembly. Insert the ends of the rack into the holes on the side of the assembly, rotating them upward to "hook" the rack into the frame.

IMPORTANT: PLEASE READ THESE INSTRUCTIONS CAREFULLY. NOTE THE SAFE OPERATIONAL REQUIREMENTS, WARNINGS AND CAUTIONS. USE THIS PRODUCT CORRECTLY AND WITH CARE FOR THE PURPOSE FOR WHICH IT IS INTENDED. FAILURE TO DO SO MAY CAUSE DAMAGE AND/OR PERSONAL INJURY AND WILL INVALIDATE THE WARRANTY. PLEASE KEEP INSTRUCTIONS SAFE FOR FUTURE USE.



WARNING

WARNING: This product contains chemicals, including lead, known to the State of California to cause cancer, birth defects or other reproductive harm. Wash hands after handling.



ATD-6561

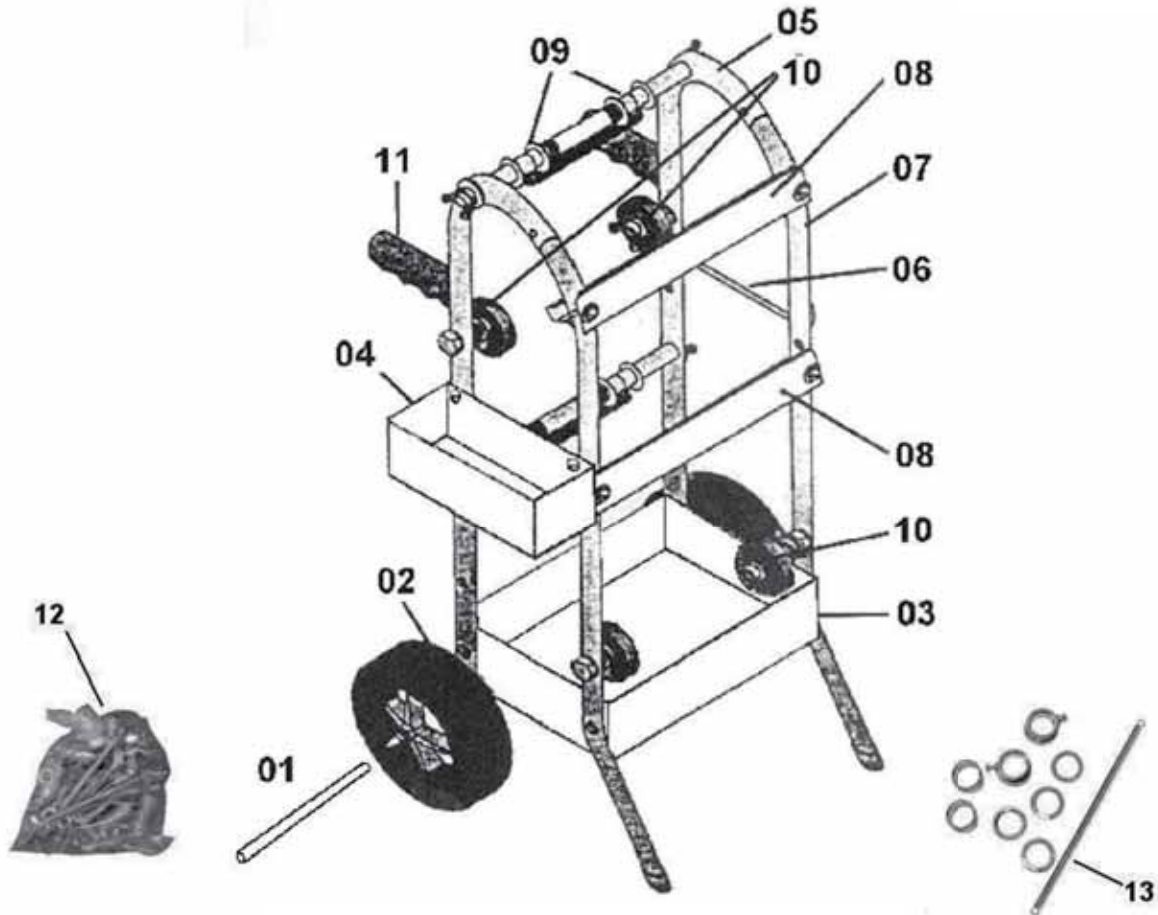

ITEM#	ORDERING PART#	PART DESCRIPTION
01	PRT6561-01	AXLE
02	PRT6561-02	WHEEL (2PC)
03	PRT6561-03	LARGE TRAY BOTTOM
04	PRT6561-04	SMALL SIDE TRAY
05	PRT6561-05	REAR FRAME (2pc)
06	PRT6561-06	TOWEL RACK
07	PRT6561-07	FRONT FRAME (2PC)
08	PRT6561-08	CUTTING BLADE (2PC)
09	PRT6561-09	PAPER REEL (2PC)
10	PRT6561-10	TAPE ROLL HOLDER (4PC)
11	PRT6561-11	HAND GRIP (2PC)
12	PRT6561-12	HARDWARE KIT
13	PRT6561-13	SPRING KIT