



Retractable 3/8 in. x 60 ft. Air Hose Reel, Parts and Technical Service Guide

Model ATD-31163

Levelwind™ Series

Please read and follow instructions carefully; otherwise, warranty may be void.

Mounting Options:

CAUTION: Maximum installation height is 15 ft. (4.5 meters) above ground. Maximum weight of hose end tools is 4 lb. (2 kg). Maximum working pressure is 300 PSI (20.68 bar). Do not stand or step on top of reel!

Mounting to wall

Positioned up to 5 ft. (1.5 m) high. Use standard replacement part L8300-W Wall /Overhead bracket

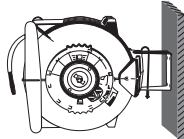

High Wall Mounting

Mount reel between 10 ft. and 15 ft. (3-4.5 m) high on wall. Use optional Bench / High Wall mounting bracket part L8300-B

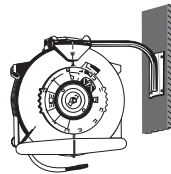

Mounting overhead

Up to 15 ft. (4.5 m) from floor. Use standard replacement part L8300-W Wall / overhead bracket.

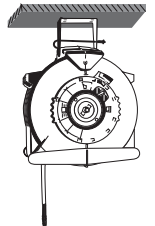

Mounting to a bench

Use optional Bench / High Wall mounting bracket part L8300-B

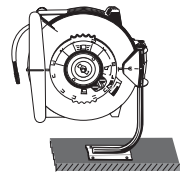

DO NOT STAND OR STEP ON REEL

Installation:

LEVELWIND™ retractable hose reels are designed for minimum assembly.

- 1) Place bracket on a flat mounting surface. With a pencil, trace bracket back holes onto surface. Use a leveling device to ensure that the bracket will be level once fastened. Fasten brackets to surface with screws (screws are not included).
- 2) Remove bracket rod (A) from bracket (B) (SEE FIGURE 1)
- 3) Place reel into bracket making sure the reel hole is aligned with bracket end holes.
- 4) Insert bracket rod through the aligned holes of reel and bracket. Insert hitch-pin clip through end of bracket rod.
- 5) Connect female end of lead-in hose to inlet connection on reel. Connect male end to air or water source (SEE FIGURE 2).

Fig. 1

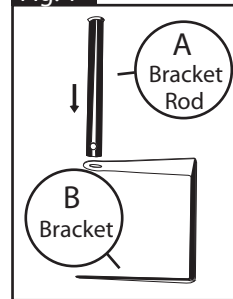
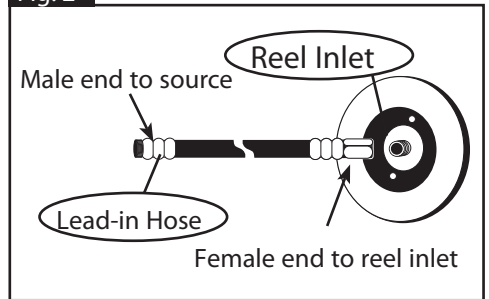

Fig. 2



Operating Instructions:

LEVELWIND™ retractable hose reels can operate in FREERUN or can be latched every 3 ft. (91 cm) by switching to the LATCHING ZONE.

Simply turn the mode switch to desired position! (SEE FIGURE 3)

THE “LATCHING ZONE”: LEVELWIND™ reels have a single latching zone. The reel can be latched for every drum revolution approx. 3 ft. (91 cm) of hose. There are audible clicking sounds as the spring loaded latch passes over the latching zone. The latching zone flips the latch so that the latch goes into or by-passes the latching position. Pulling hose straight out off the reel “flips the latch” so it can go into the latching position. Retracting the hose into the reel keeps the latch “flipped” so that the latch by-passes the latching position.

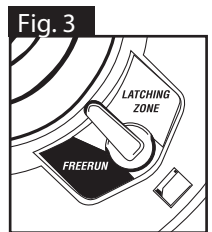

FREERUN MODE: The hose does not latch in this mode. Hose will automatically retract back into reel. The hose stopper position may be adjusted to desired length for application (SEE FIGURE 4) **CAUTION!** Do not release the end of the hose when rewinding as personal injury or damage could result!

LATCHING - Pull out the desired length of hose. As you are pulling out hose from the reel, listen for a “click”. STOP! Don’t pull any further! If you keep pulling out hose (more than 14 in. (36 cm)) after hearing the “click”, you will have pulled past the latching zone. Now, allow the hose to go back into the reel (less than 14 in. (36 cm)) and the latch will drop into the latching position. The reel is now latched!

RETRACTING - Assuming the latch is engaged in the latching position, pull out hose until you hear a “click” (approx. 14 in. (36 cm)). STOP! Don’t pull any further! If you pull out more than 3 ft. (91 cm) of hose after hearing the “click”, you will have gone a full drum revolution and back into the latching zone where the reel will once again be latched. Now, allow the hose to retract back into the reel.

The hose reel will continue retracting hose until it is fully retracted. If you decide to re-latch the reel while you are still retracting hose, simply listen for a click. STOP! Slowly pull out hose until you hear a second click. STOP! Don’t pull any further. Now, slowly allow the hose back into the reel (less than 14 in. (36 cm)) and the latch will drop into the latching position. The reel is now latched.

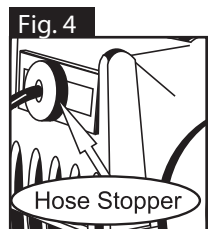

SEVEN POSITION LOCKING BRACE

LEVELWIND retractable hose reels can swing freely on bracket or can be locked in one of seven positions, allowing for specific mounting requirements.

Standard bracket

- 1) Remove bracket rod from reel. (SEE FIGURE 5A)
- 2) Place seven position locking brace over bracket so that bracket rod holes are aligned. Replace bracket rod so that brace, reel & bracket are attached. Insert hitch-pin clip through end of bracket rod. (SEE FIGURE 5B)
- 3) Rotate bracket so that it is at desired angle & lock into place with fastener. (SEE FIGURE 5B)

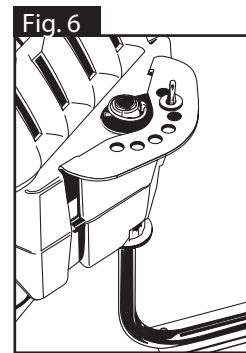
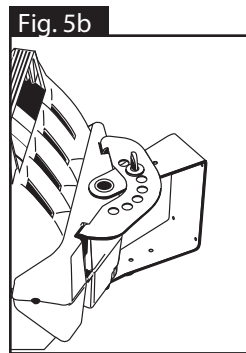
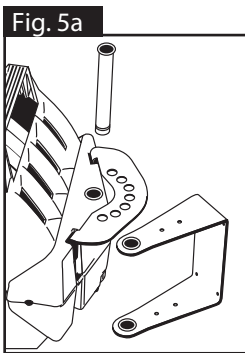

Optional Bench/High Wall Mounting Bracket (see figure 6)

Maintenance Procedures

TENSION ADJUSTMENT:

This reel is preloaded with spring tension that is set at the factory. If the reel becomes completely un-tensioned, please identify your hose reel model number referenced in the Factory Preset Tensioning Table to find out how many turns are needed for proper tensioning. If a heavy air tool is attached to the end of the hose, you may need to add tension to overcome the weight of this tool. DO NOT EXCEED one full turn past the number of turns listed in the Factory Preset Tensioning Chart at right.

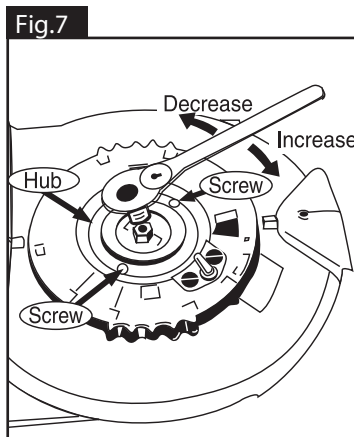

Factory Preset Tensioning Table

Model #	# of Turns
L8361FZ-ATD	5

TOOLS REQUIRED:

Phillips Screw Driver, 3/4 in. Socket Wrench

- 1) Lay reel on its side. (SEE FIGURE 7)
- 2) Place wrench on hub fitting plate nut. HOLD WRENCH FIRMLY.
- 3) Unscrew hub. DO NOT REMOVE SIDEPLATE.
- 4) Turn wrench either 1/2 turn or no more than one full turn. Turn clockwise to increase tension. Turn counterclockwise to decrease tension.
- 5) Replace hub plate screws and tighten. Return reel to mounting bracket.

HOSE REPLACEMENT:

To ensure proper performance, please consult the Hose Replacement Kit table for the appropriate part number to order. Call your point of sale or your local ATD distributor to order parts.

Replacement Hose Kits

- 1) Pull entire length of hose out of reel. (SEE FIGURE 8)
- 2) While entire length of hose is out of the reel, place long screw driver (3/8 in. in diameter (9 mm)) all the way through the hole located at the back portion of reel. This eliminates any chance for the reel to retract while replacing hose.

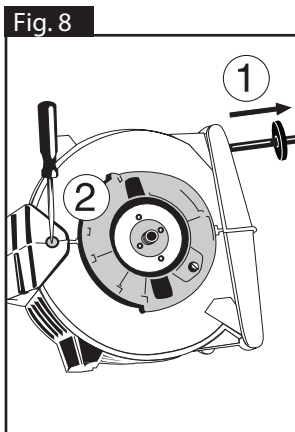

Replacement Hose Kits

Part #	Description
RP005316-FZ-ATD	Replacement Hose Assembly

Sideplate removal

- 3) Locate inlet sideplate. Remove four fasteners (SEE FIGURE 9). While placing fingers on grooves located on the top and bottom of sideplate, depress locking tabs at the same time with thumbs (SEE FIGURE 10). Rotate side plate either way until sideplate unlocks. Remove sideplate.
- 4) Remove wear plate (SEE FIGURE 11). Unscrew two fasteners on wear ring and remove wear ring (SEE FIGURE 12).

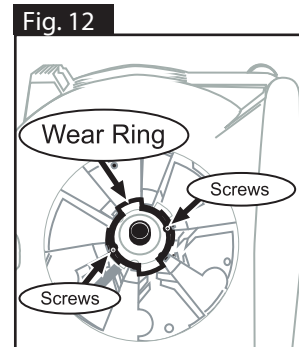
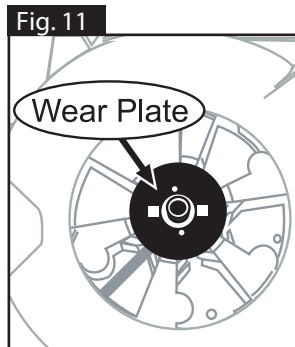
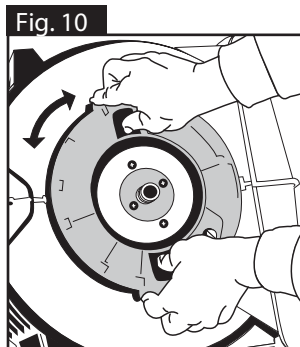
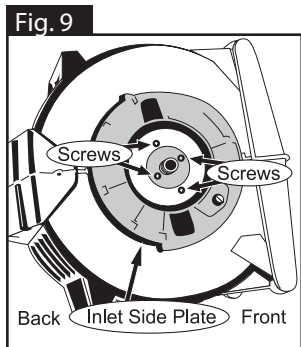

- 5) Pull swivel assembly firmly from hose spool(SEE FIG. 13 and 14).
- 6) Unscrew Hose Clamp and pull hose off hose barb on swivel. (SEE FIGURE 15)
- 7) Pull remaining length of hose out reel opening located at the reel front.
- 8) Take replacement hose through opening located at the front of reel. Thread hose through hose leveling mechanism. (SEE FIGURE 16)
- 9) Insert hose through the center of the hose spool. Four openings are referenced with the following hose I.D. dimensions located at the center of hose spool: 3/8 in., 1/2 in., 5/8 in. & 3/4 in.. Locate the hose I.D. and pull through that opening. (SEE FIGURE 17) Pull enough hose to allow the hose to connect to hose barb on swivel.
- 10) Replace hose onto hose barb, tighten hose clamp onto hose & place swivel into hose spool housing.
- 11) Replace wear ring and fasten with wear ring screws. Replace wear plate so that the swivel drive tabs insert into wear plate tab receivers. (SEE FIGURE 18)
- 12) Replace sideplate so that the plate snaps flush to side of reel. Turn sideplate until locking tabs connect to sideplate.
- 13) Turn swivel so that fastener holes of swivel and sideplate align. Replace the four sideplate fasteners and tighten.
- 14) Remove screw driver.
- 15) Retract hose back into reel.

SWIVEL REPLACEMENT

IMPORTANT: To ensure proper performance, please refer to the Swivel Replacement Kit table to order the correct part number. Call your point of sale or your local ATD distributor to order parts.

Swivel Kits	
Part #	Description
RP005007-38	Swivel Replacement kit

- 1) Repeat steps 1- 6 in the HOSE REPLACEMENT procedure.
- 2) Place hose onto hose barb of new swivel body. Tighten hose clamp onto hose & place swivel into hose spool housing.
- 3) Replace wear ring and fasten with wear ring screws. Replace wear plate so that the swivel drive tabs insert into wear plate tab receivers. (SEE FIGURE 18)
- 4) Replace sideplate so that the plate snaps flush to side of reel. Turn sideplate until locking tabs connect to sideplate.
- 5) Turn swivel so that fastener holes of swivel and sideplate align. Replace the four sideplate fasteners and tighten.
- 6) Remove screw driver.
- 7) Retract hose back into reel.

Troubleshooting	
1) HOSE WILL NOT RETRACT	<ol style="list-style-type: none"> 1a. Pull on hose, push latching switch to FreeRun mode. Retract hose into reel. 1b. Spring is broken. Call service center.
2) HOSE WILL NOT FULLY RETRACT	<ol style="list-style-type: none"> 2a. Spring tension too light? 2b. Replacement hose too heavy? 2c. Hose not retracting evenly? Is the Levelwind™ mechanism not working properly?
3) REEL WILL NOT LATCH	<ol style="list-style-type: none"> 3a. Are you releasing hose too quickly? 3b. Broken latching pawl or mode switch?
4) REEL LEAKS	<ol style="list-style-type: none"> 4a. Damaged hose? 4b. Loose fittings? 4c. Worn swivel seals?

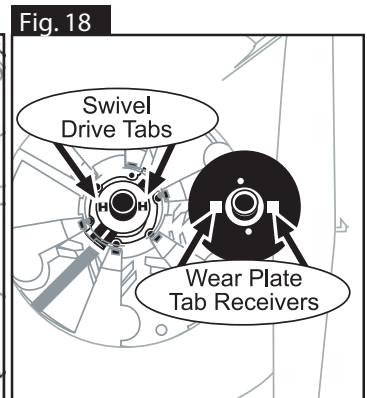
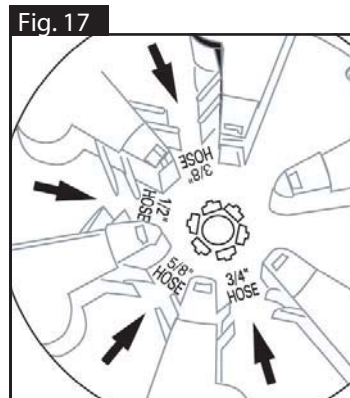
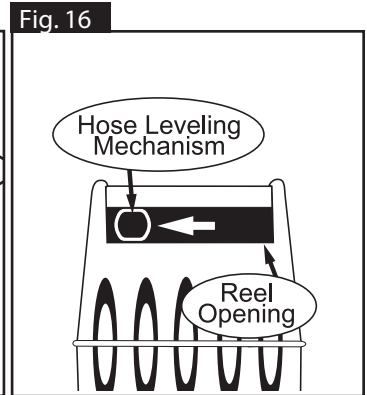
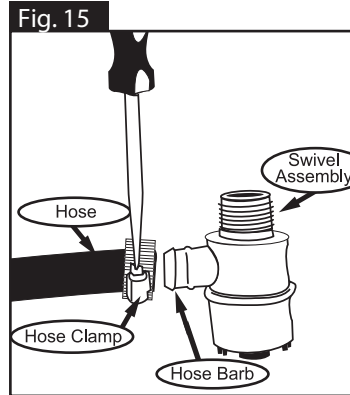
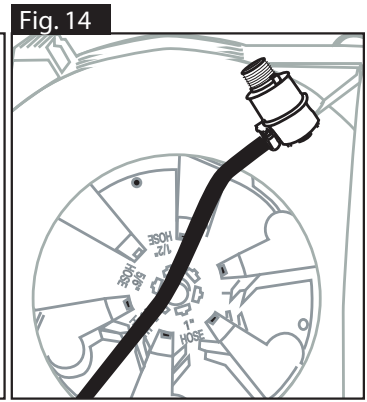
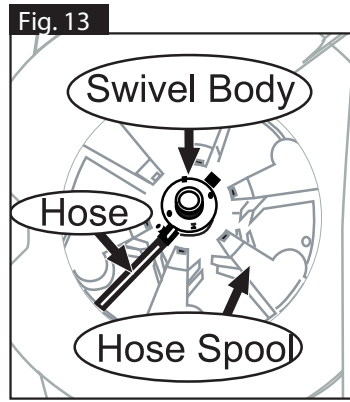

TECHNICAL ASSISTANCE:
CALL 800-645-8258 IF YOU HAVE ANY QUESTIONS REGARDING THE INSTALLATION OR OPERATION OF THIS REEL.

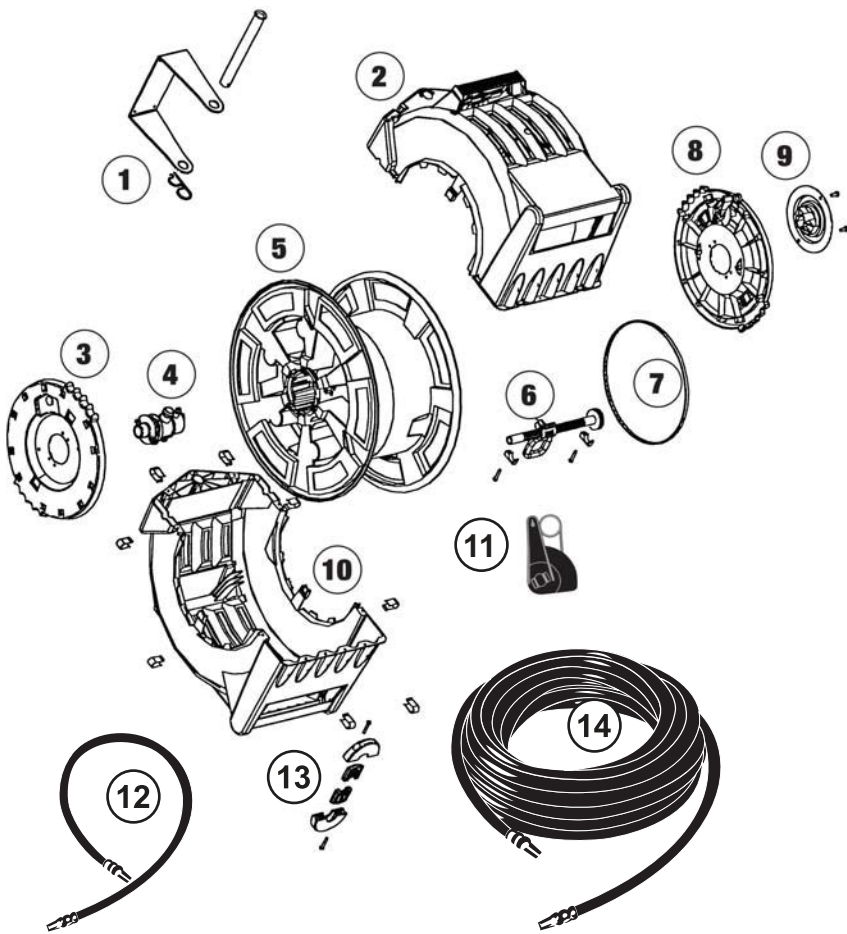

Optional Bench & High Wall Mounting Bracket

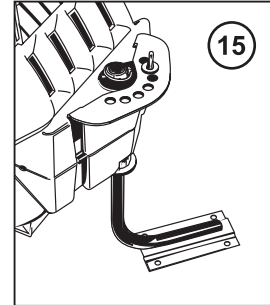

Air Hose Specs:

- Lays flat, no memory
- Kink resistant under pressure
- Extreme all-weather flexibility, even in sub-zero temperatures! (-40° to 150° F)
- Maximum working pressure: 300 PSI
- 3:1 Safety factor
- Excellent abrasion-resistant outer cover
- Includes bend restrictor that reduces wear and tear, prolonging the life of the hose

ATD Tools, Inc. One Year Limited Warranty

ATD Tools offers a one (1) year Limited Warranty. ATD warrants its products, supplied and manufactured, to be free of defects in materials and workmanship for a period of one (1) year following the date of purchase. This warranty does not apply to any product which has been misused, abused, or altered in any way, or worn out from use. The one year warranty does not apply to consumable products which, by nature of their application will wear out in normal use. Such products are, but are not limited to gloves, seals on pumps, nuts, bolts, washers, cotter pins etc. All ATD warranties are handled at the point of sale. Return products to place of purchase, with proof of purchase, for repair or replacement at their option. Repair charge, if any, and return transportation will be invoiced depending on the condition of the tools and parts required. In no event will ATD Tools be liable for incidental or consequential damages. ATD Tools liability for any claim for loss or damages arising out of the sale, resale or use of any ATD Equipment shall in no event exceed the purchase price. Some jurisdictions do not allow the exclusion or limitation of incidental or consequential damages, therefore the above limitation or exclusion may not apply to you. This warranty gives you specific legal rights. You may also have rights that vary from State to State.

WARNING: This product contains one or more chemicals known to the State of California to cause cancer and birth defects or other reproductive harm. Wash hands after handling.

Repair Parts		
Ref. #	Repair Part	Description
1	L8300-W	Bracket for wall or overhead ceiling mounting
2	RP005000BK	Outer Top Case w/Trim Ring Black
3	RP005002BK	Swivel Plate Side Assembly Black
4	RP005007-38	Swivel Body Assembly 3/8 in. hose
5	RP005015	Drum Assembly
6	RP005010-20	Layering Device Assembly
7	RP005012-140	Drive Belt
8	RP005004BK	Latch Plate Side Assembly Black
9	RP005003	Tension Cover
10	RP005001BK	Outer Bottom Case Black
11	RP005018	Latch Spring and Pawl
12	8305FZLI	5 ft. x 3/8 in. Lead-in Hose
13	RP005026	Hose Stopper for 3/8 in. hose
14	RP005316-FZ-ATD	Hose
15	L8300-B	Optional Bench & High Wall Mounting Bracket

Levelwind™ is a trademark of Legacy Manufacturing Company